

MetLogix

M³

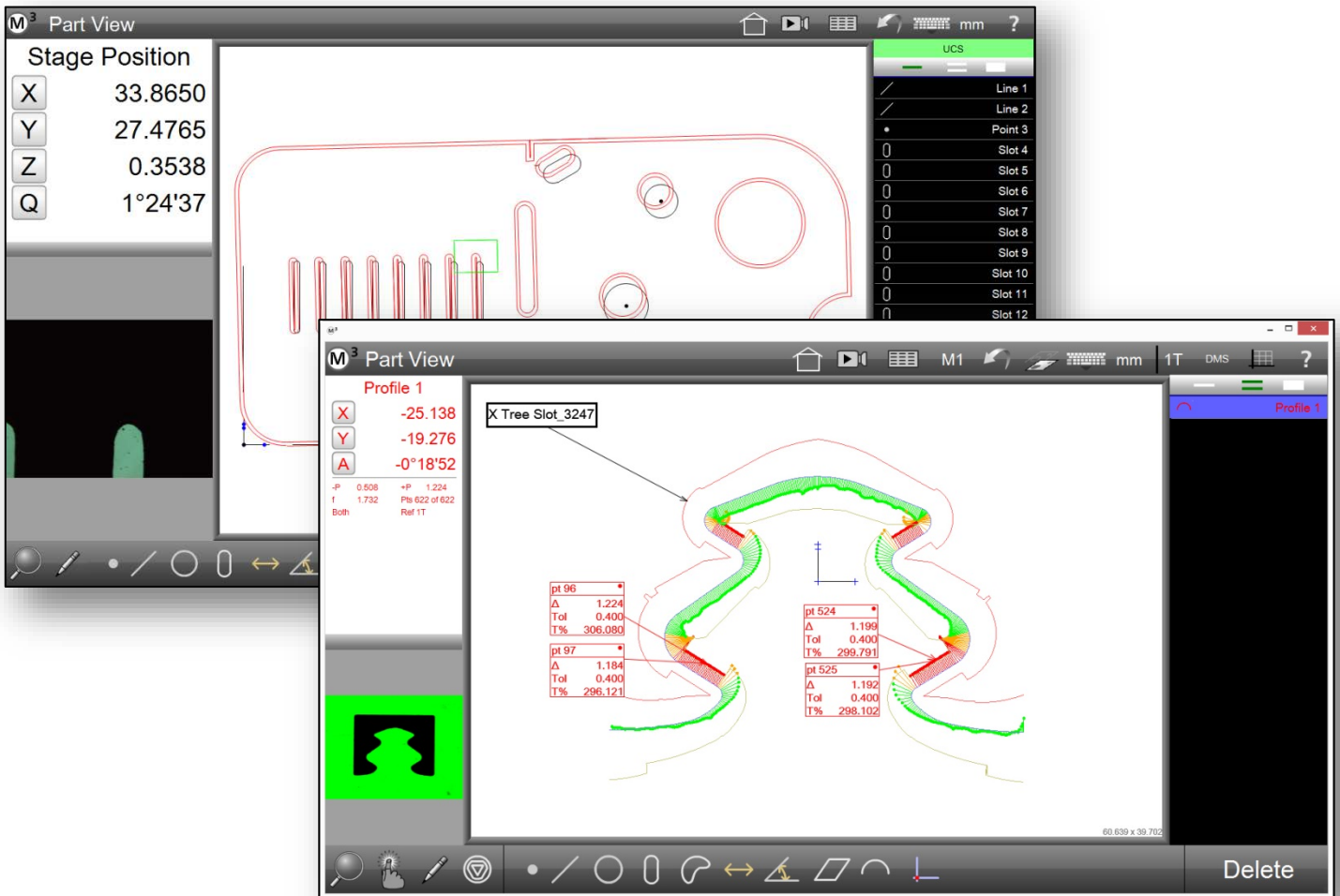

Digital Comparator and Profile Fit Options for M3V2 Software

User's Guide

Digital Comparator and Profile Fit Options for M3V2 Software

User's Guide

Crosshair and Video Edge Detection

Metlogix Incorporated
175 Canal Street
Manchester, NH 03101 USA
Telephone 603.836.4452
Facsimile 603.369.6499
info@metlogix.com
www.metlogix.com



Digital Comparator and Profile Fit Options for M3V2 Software User's Guide

Published by:
Metlogix Incorporated
175 Canal Street
Manchester, NH 03101 USA

User's Guide part number: 15010-00 Rev 1
Publishing date: December, 2015
Printed in United States of America
Copyright © 2015 by Metlogix, Incorporated, Manchester, New Hampshire

M3 software version: 2.10.00

All information set forth in this document, all rights to such information, any and all inventions disclosed herein and any patents that might be granted by employing the materials, methods, techniques or apparatus described herein are the exclusive property of Metlogix, Incorporated., Manchester, New Hampshire.

Terms, conditions and features referenced in this document are subject to change without notice.

No part of this document may be reproduced, stored in a retrieval system, or transmitted in any form or by any means, electronic, mechanical, photocopying, recording, or otherwise, without prior written permission of Metlogix, Inc... Requests to Metlogix, Inc. for permission should be addressed to the Customer Services Department, Metlogix, and Incorporated. 175 Canal Street, Manchester, New Hampshire 03101.

Limit of liability and disclaimer of warranty

While this guide was prepared with great care, Metlogix makes no representations or warranties with respect to the accuracy or completeness of the contents of this book and specifically disclaims any implied warranties of merchantability or fitness for a particular purpose. The advice, methods and instructions contained in this book might not be suitable for your situation. When in doubt regarding suitability, you are encouraged to consult with a professional where appropriate. Metlogix shall not be liable for any loss of profit or any damages, including but not limited to special, incidental, consequential or other damages.

Trademarks

Metlogix, is a registered trademark of Metlogix, Incorporated. Windows is a registered trademark of the Microsoft Corporation in the United States and other countries.

Contents

Introduction

M3V2 DC/PF Option Features and Benefits.....	1
Encoded and Fixed Stage Support.....	1
Design Custom DXF Crosshair Probes.....	1
Create Feature-Based Video Overlays.....	1
Import DXF Files to Create Video Overlays.....	1
Export Features to DXF.....	1
Pattern Teach and Recognition.....	1
Multi-Touch Software Control.....	1
Measure Profile Fit.....	1
Is My Software Configured for the DC/PF Option?.....	2

Video Window Crosshair and Overlay Image Tools

Pan/Rotate.....	3
Shifting a Probe or Overlay in XY Pixel Space Using the Pan/Rotate Button.....	3
Shifting a Probe or Overlay in XY Pixel Space Using the Computer Keyboard.....	3
Rotating a Probe or Overlay Around a User-defined Rotation Point Using the Rotation Buttons.....	3
Rotating a Probe or Overlay Using the DRO Q-Axis.....	4
Rotating a Probe or Overlay Using the Computer Keyboard.....	4
Color of Probe or Overlay.....	4
Tolerance Error Whiskers (overlays).....	4
Screen Mode/ Part Mode (overlays).....	5

Creating custom crosshair probes

Assigning Datum Zero to the Center of Your Custom Crosshair Probe.....	6
--	---

Using Factory Default and Custom Crosshair Probes

Factory and Custom Crosshairs.....	8
------------------------------------	---

Creating and Using Feature Overlays

Creating a Feature Overlay.....	8
Line Overlay.....	9
Circle Overlay.....	9
Slot Overlay.....	9
Rectangle Overlay.....	9
Angle Overlay.....	9
Using a Feature Overlay.....	10

Creating and Using DXF Overlays

Creating DXF Overlays.....	11
Importing DXF Files	11
Moving the Datum Location of imported DXF Part File	12
Constructing Profile Features	13
Applying Tolerance Zones to Profile Features	13
Assigning Material Conditions to Profile Tolerance Zones	15
Saving Profile Features as DXF Overlays.....	16
Converting Profile Features to Digital Comparator Overlays	17
Using DXF Overlays	18
Opening an Existing DXF Overlay.....	18
Manipulating DXF Overlays.....	18
Measuring Overlay Offset.....	19

Exporting Features as DXF Files

Exporting .dxf files	20
----------------------------	----

Pattern Recognition and Program Playback

Teaching a pattern.....	21
Datum Pattern Measurement.....	21
Standard Pattern Measurement.....	22
Pattern Program Playback.....	22
Viewing the Image Source for Pattern Features	23

Freezing Live Video Images

Freezing in Field of View	24
---------------------------------	----

Profile Fit Functions

Terminology/Nomenclature	24
Operation	26
Work Flow #1: Measuring a Profile Using a .dxf CAD File	26
Measuring a profile within a part program	27
Workflow #2: Converting a .dxf Overlay to a Profile Tool	28
Workflow #3: Performing a profile Measurement Using a .dxf Overlay File	29
Set up and miscellaneous functions.....	30
Profile settings	30
Non-uniform tolerancing.....	30
Edit and Record into	30
Profiling Constraints.....	30
Exporting Profile Measurement Data Cloud	31

SOFTWARE LICENSE AGREEMENT

1. Definitions..... 33

2. Software License 34

 2.1 Limited Use..... 34

 2.1.3 General Use 34

 2.1.4 Distribution from a Server..... 34

 2.1.5 Dual Boot Platform 34

 2.1.6 Documentation 34

3. Intellectual Property Ownership 35

4. Restrictions and Requirements 35

 4.1 Notices..... 35

 4.2 Use Obligations 35

 4.3 No Modifications 35

 4.4 No Reverse Engineering 35

 4.5 No Unbundling..... 35

 4.6 No Transfer..... 35

 4.7 No Service Bureau 35

 4.8 MetLogix M Series Restrictions..... 36

5. Updates 36

6. Limited Warranty 36

7. Disclaimer..... 36

8. Limitation of Liability 37

9. Export Rules 37

10. General Provisions 37

11. Notice to U.S. Government End Users 37

12. Compliance with Licenses..... 38

13. Peer to Peer Communications 38

Digital Comparator and Profile Fit Software User's Guide

Introduction

The M3V2 Digital Comparator and Profile Fit (DC/PF) optional software package adds many important features and benefits to the standard M3V2 measuring software application. This document covers the main features of these software options and provides many examples of their use.

Note

The concepts presented in this guide rely on an understanding of the basic features and functions of the M3V2 software application. Please make sure that you're familiar with the M3V2 software before proceeding.

M3V2 DC/PF Option Features and Benefits

Encoded and Fixed Stage Support

This software option adds important functionality to encoded (moveable) and fixed stage systems. All of the features and functions included are available regardless of system type.

Design Custom DXF Crosshair Probes

Design your own DXF-based crosshair graphic for use in the M3 software systems. Use the custom crosshair to measure features by translating it in XY space or rotating it around a user-defined data collection point. Change the crosshair color quickly to accommodate various image and lighting conditions.

Create Feature-Based Video Overlays

Use the M3V2 feature overlay function to create on-screen video charts for quick visual comparisons of measured part features to user-defined tolerance zones. The ability to create circle, line, slot, rectangle and angle feature forms provides the flexibility to support a wide range of applications.

Import DXF Files to Create Video Overlays

Import DXF part files to be displayed as overlays in the Live Video window. Translate, rotate and change the color of your DXF overlay to inspect part fit in the Live Video window. Display tolerance error whiskers for the portions of the part image that do not fall within the user-defined tolerance zones of the original DXF part file. Use the measure distance and measure angle functions to quickly calculate the positional and angular offset between your DXF overlay and the part coordinate system established within the M3V2 software.

Export Features to DXF

Export features measured with the M3V2 software in the industry-standard DXF file format for use with other software applications.

Pattern Teach and Recognition

Teach the system specific image patterns for automatic detection during CNC program playback. Increase the robustness and efficiency of program playback through the **soft-fixturing** part positioning system using the pattern detection mechanism.

Multi-Touch Software Control

Pan, rotate and zoom DXF overlays and custom crosshair probes with a simple touch using the expanded Multi-Touch logic function.

Measure Profile Fit

Compare a DXF part overlay file containing position, angle and tolerance data to a corresponding part shown in the live video window. Show resulting color coded tolerance error whiskers in the Part View window and overall profile position, angle and form in the Part Detail window.

Digital Comparator and Profile Fit Software User's Guide

Important Note

The use of the DC/PF options require the M3V2 version V2.10.00 software or later and that the options are enabled for your system. In addition, the Encoder Interface Module being used must have the required hardware option programming to support this feature. Please contact your Metlogix representative for information regarding enabling the options for your system.

Is My Software Configured for the DC/PF Option?

Systems that support the DC/PF capability will display the software version number and supported options in the About Settings screen of the M3 System menu. To determine your M3 system software version and option support:

- 1) Press the M3 logo in the System toolbar to display the System menu.
- 2) Press the Settings button to display the M3 Settings screen menu.
- 3) Press the About button to display the M3 version number and option support. This option is only supported by versions the 2.10.00 and greater.

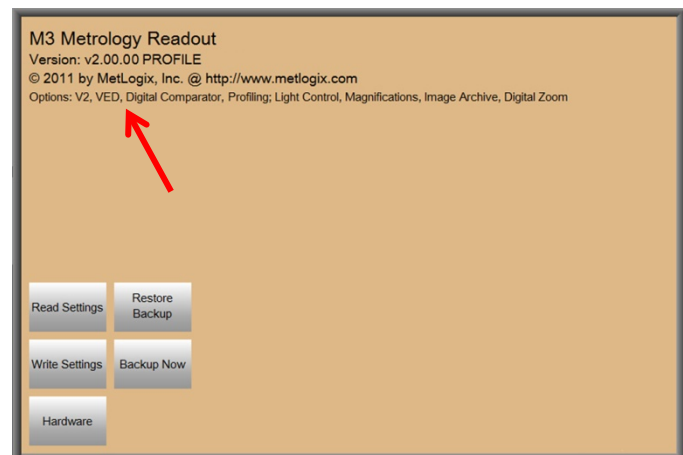
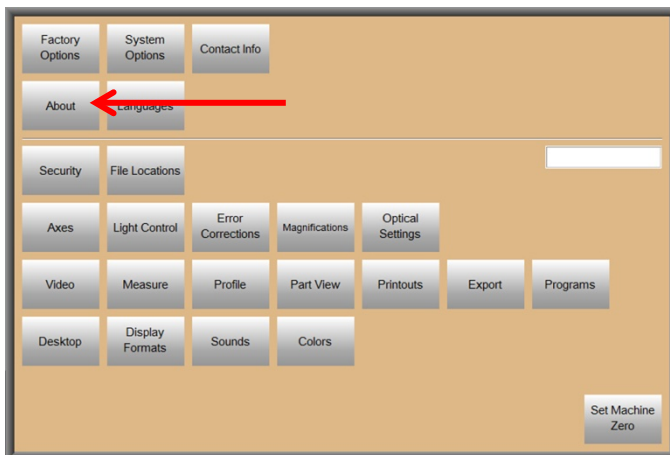
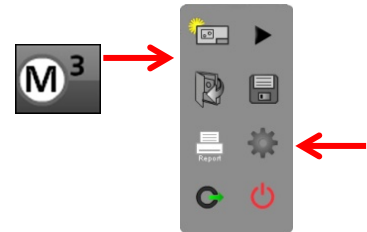

Video Window Crosshair and Overlay Image Tools

When a Probe or DXF overlay is displayed in the Live Video window, three or four buttons are shown in the top-left portion of the window. These image tools are described here because their use is common to the probes and overlays that are described throughout the remainder of this guide. Brief summary descriptions are provided in various sections of the guide but will rely on the following detailed description to provide a thorough understanding of the tools. The image tools include:

- Pan/Rotate
- Color of probe or overlay
- Tolerance error whiskers (used for overlays)
- Screen mode/Part mode (used for overlays)

Pan/Rotate

This button is used to shift the probe or overlay in XY pixel space, or to rotate it around a rotation point defined by the user. Press the Pan/Rotate button to toggle between the Pan and Rotate functions. Long-press the Pan/Rotate button to return the probe or overlay to its original position.

Shifting a Probe or Overlay in XY Pixel Space Using the Pan/Rotate Button

The probe or overlay is shifted in the XY pixel space using the Pan function. To shift a probe or overlay:

- 1) Toggle the Pan/Rotate button to the Pan mode. 
- 2) Press and drag the probe or overlay to align it with the part features in the desired orientation.



Shifting a Probe or Overlay in XY Pixel Space Using the Computer Keyboard

To shift a probe or overlay using the computer keyboard arrow keys:

- 1) Toggle the Pan/Rotate button to the Pan mode. 
- 2) Use the Up, Down, Left and Right keyboard arrow keys to shift the probe or overlay. Press the Shift key while pressing an Arrow key to multiply the movement X 5.

Rotating a Probe or Overlay Around a User-defined Rotation Point Using the Rotation Buttons

To rotate the probe or overlay:

- 1) Press the Pan/Rotate button to toggle it to the Rotation mode.  Rotation and Rotation Point buttons will be displayed.
- 2) Press the Rotate Point button. A Rotate Point indicator  will appear in the center of the Live Video window.
- 3) Press and drag the Rotate Point indicator to the desired center of rotation and then press and drag-rotate the probe or overlay to align it with the part. An overlay of two circles is shown here.

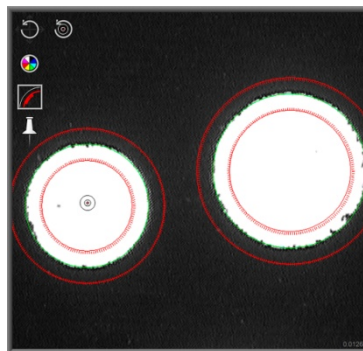
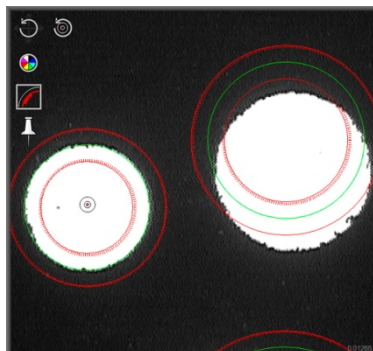

Digital Comparator and Profile Fit Software User's Guide

Rotating a Probe or Overlay Using the DRO Q-Axis

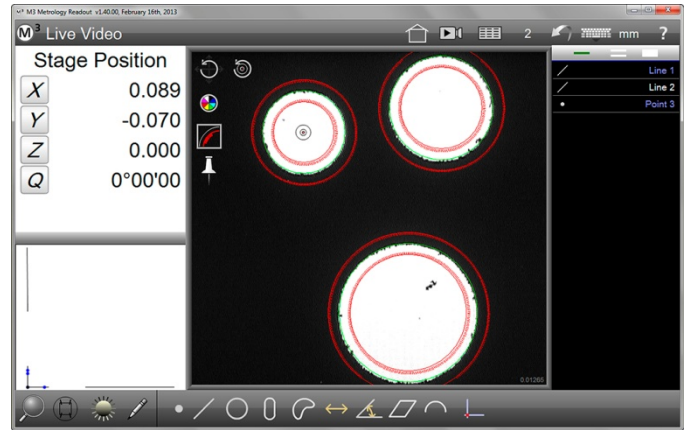
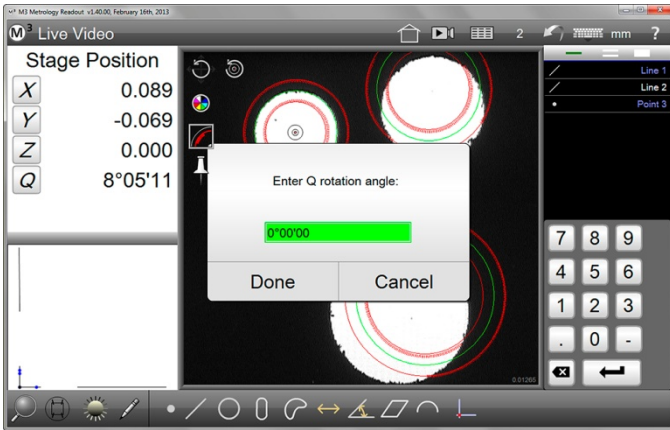

To rotate the probe or overlay using the DRO Q-Axis:

- 1) Press the Rotate Point button. A Rotate Point indicator  will appear in the center of the Live Video window.
- 2) Press and drag the Rotate Point indicator to the desired center of rotation.
- 3) Long-press the DRO Q-Axis to display the Q-Rotation dialog, enter the desired rotation value and then press Done. The probe or overlay will be rotated to the value entered into the dialog window.



Rotating a Probe or Overlay Using the Computer Keyboard

To rotate a probe or overlay using the computer keyboard up and down arrow keys:

- 1) Toggle the Pan/Rotate button to the Rotate mode. 
- 2) Press the Rotate Point button. A Rotate Point indicator  will appear in the center of the Live Video window.
- 3) Press and drag the Rotate Point indicator to the desired center of rotation.
- 4) Use the Up and Down keyboard arrow keys to rotate the probe or overlay. Press the Shift key while pressing an Arrow key to multiply the movement X 5.

Color of Probe or Overlay

This button is used to change the color of the probe or overlay as described below:

- 1) Press the Color button repeatedly to cycle through the eight display colors.

Note

Overlay colors cannot be changed when tolerance error whiskers indicate a tolerance failure.

Tolerance Error Whiskers (overlays)

The Tolerance Error Whisker button is used to enable or disable the display of red whiskers at the points where part edges fall outside an assigned overlay tolerance zone. A circle overlay is shown here. To show overlay tolerance zone failures:

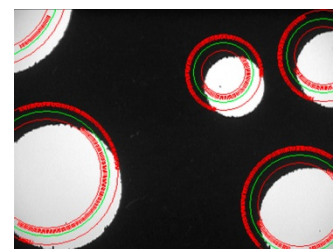

- 1) Toggle the presentation of error whiskers to enabled. 



Digital Comparator and Profile Fit Software User's Guide

Screen Mode/ Part Mode (overlays)

Overlays can be displayed in the screen mode or the part mode. The Push Pin button is used to toggle between the screen and part modes.

- Screen mode 
- Part mode (pinning the overlay) 

There are two important differences between the screen and part mode overlays:

1) Part mode: the overlay remains attached (pinned) to the part when the stage is moved, and moves with the part.

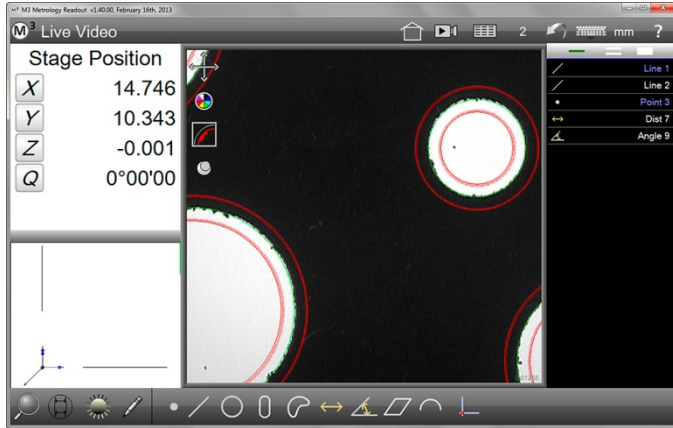

Screen mode: the overlay remains in a fixed position on the screen when the stage is moved.

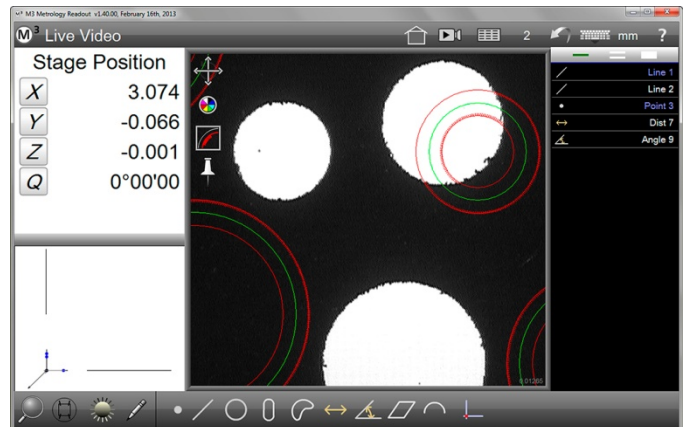
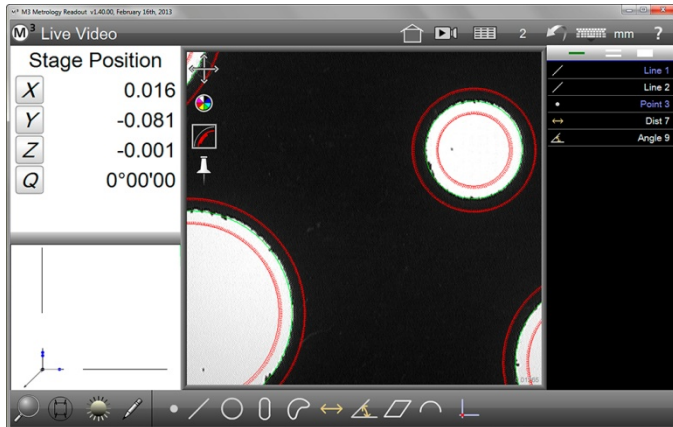

2) In the screen mode, long-pressing the Pan/Rotate button aligns the center of the .dxf overlay file bounded region with the center of the Live Video window (screen zero). In the part mode, long-pressing the Pan/Rotate button aligns the overlay datum zero position with the part datum zero position.

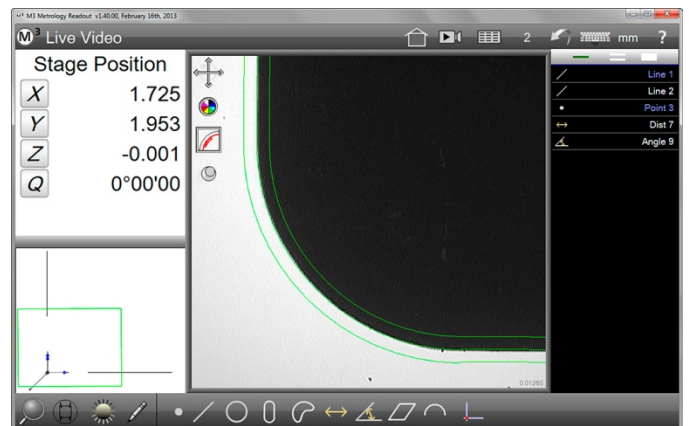
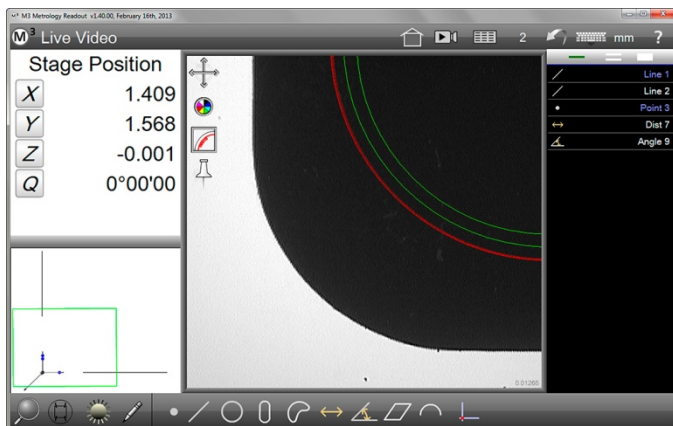

Creating custom crosshair probes

The M3 system provides a simple crosshair probe as the default. However, crosshair probes can be developed in any DXF authoring program and presented in the M3 Live Video window. To create a custom crosshair probe:

1) Draw the desired crosshair probe in the DXF authoring program of your choice. Some guidelines for crosshair probe development include:

- Crosshair dimensions: 30" x 20"
- Crosshair line weight: 20 points or greater
- Assign datum 0 to the center of the crosshair probe
- Crosshair lines in X or Y orientations are visually more pronounced than circular lines

2) Export the custom crosshair as:
crosshair.dxf.

Export the custom crosshair file to the:
C:\users\Public\public documents\metlogix\settings directory.

3) Save your new DXF probe design in a secure location.

Assigning Datum Zero to the Center of Your Custom Crosshair Probe

The default center of the new custom crosshair probe must be at the center of the M3 Live Video window. If your custom crosshair probe does not have datum zero assigned to the center, the probe's DXF file can be imported and the datum zero position can be assigned in the M3 software. To assign datum zero to the center of the probe:

1) Press the M3 logo and then press the Import button. The Open Part File dialog will be displayed.

2) Select the DXF file type and then use the Explorer tools on the left to navigate to:

C:\users\Public\public documents\metlogix\settings

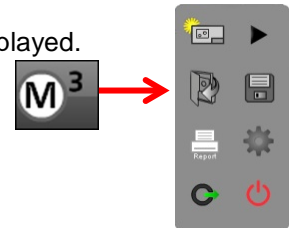

3) Select the crosshair.dxf file and then press Open. The import Crosshair.dxf dialog will be displayed.

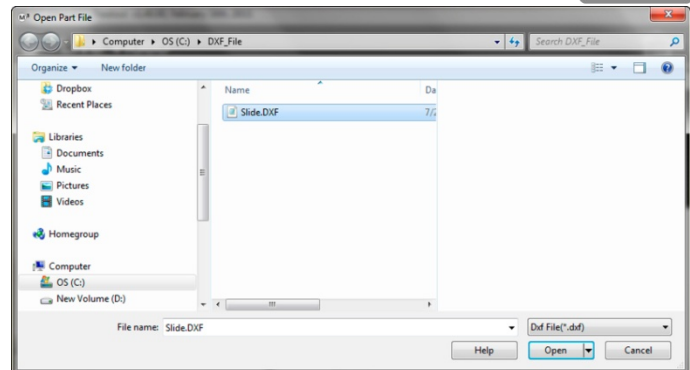
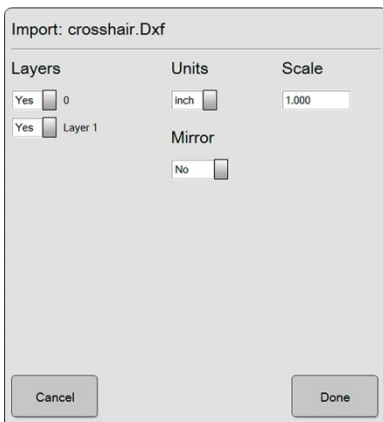

4) Press Done to import the custom crosshair file.

Digital Comparator and Profile Fit Software User's Guide

5) Press the Part View window to display the crosshair file in the center window.

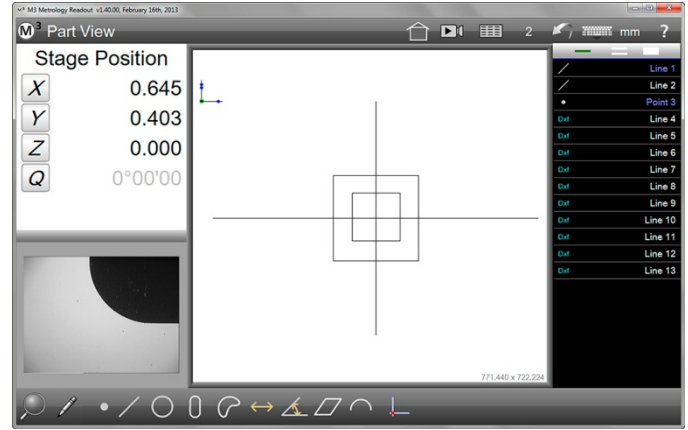
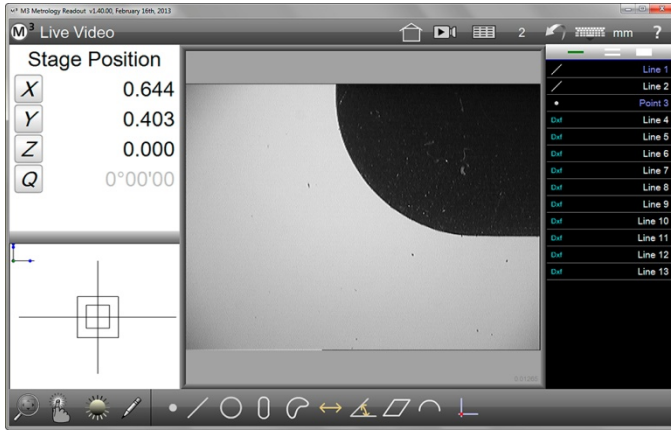

6) Press the Measure Datum button in the Measure Toolbar and then select the primary X and Y crosshair lines (or primary central feature). Press Done to complete the datum orientation.

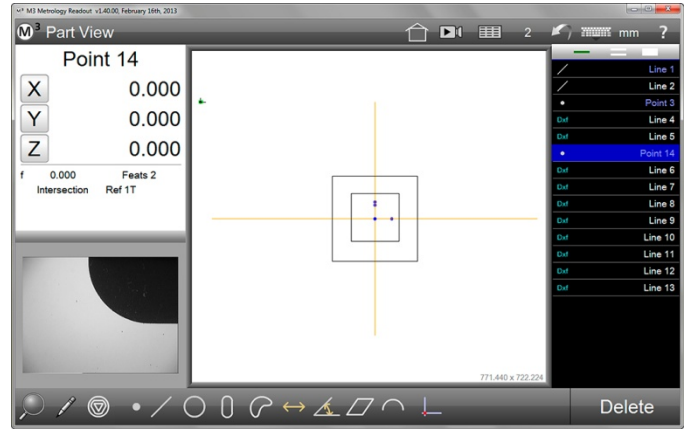
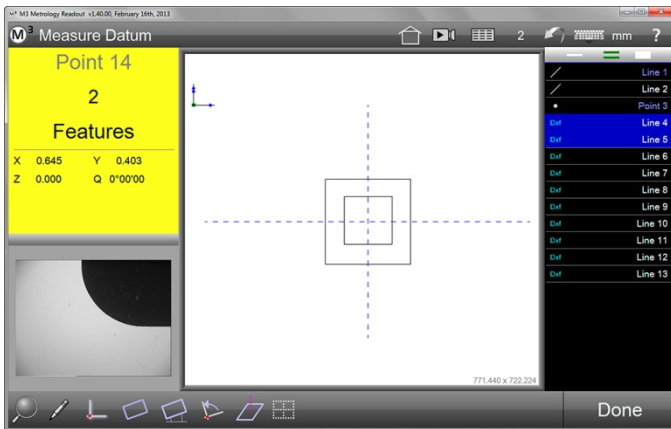

7) Press the Report button in the top menu bar and then press the Export button in the Report menu bar to display the Export menu.

8) Press DXF in the Export menu. Navigate to the:
C:\users\public\public documents\metlogix\settings directory
Save the file as crosshair.dxf. Replace the existing file.

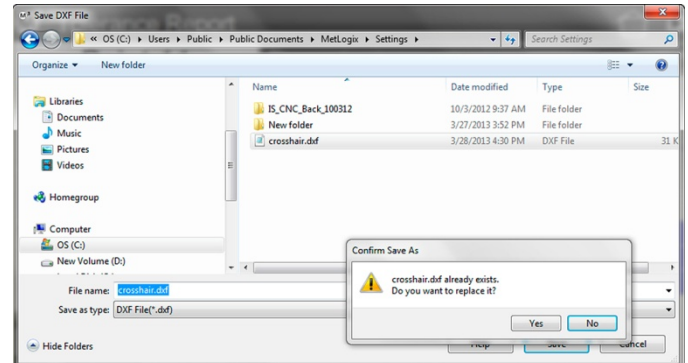
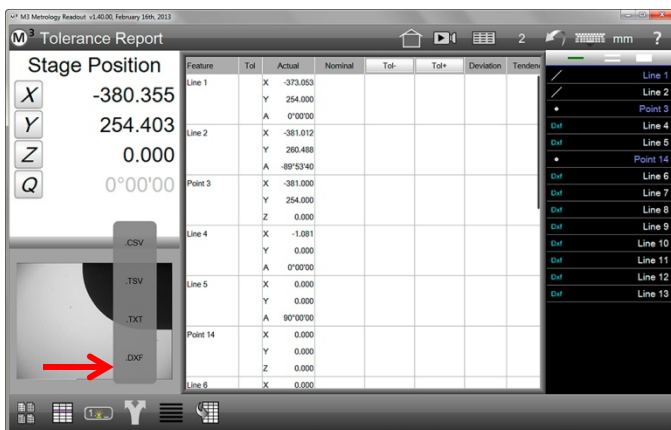

9) Close and then reopen the M3 application.

Digital Comparator and Profile Fit Software User's Guide

10) Press the Probe button in the Measure toolbar and then select the simple crosshair probe. Your new custom crosshair will be displayed.

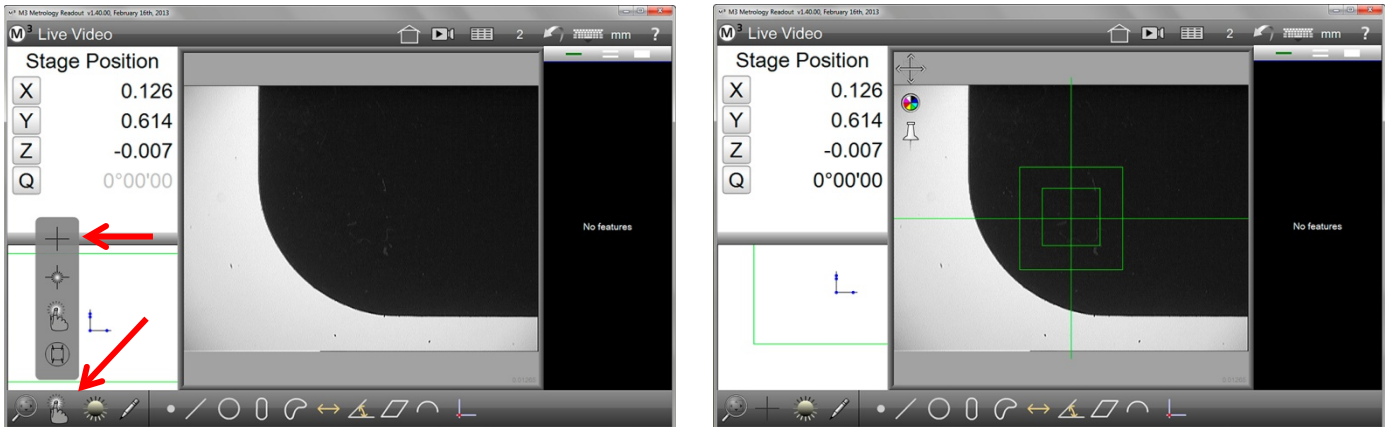

11) To return to the default simple crosshair probe, delete or rename the crosshair.dxf file in the C:\users\Public\public documents\metlogix\settings directory.

Using Factory Default and Custom Crosshair Probes

The use of simple factory default and custom crosshair probes is identical.

- Select the crosshair probe from the Probe menu
- Select the Measure Feature button for the target feature
- Position the crosshair on edge of the feature where you would like to collect the first point
- Press Enter or in the yellow Measure Feature region to enter a point at the current crosshair position
- Repeat this process until all the required points have been entered
- Press done to complete the measurement. The feature will be added to the Feature List and the Part View

Crosshairs can be manipulated in the live video window as described earlier in the section: [Video Window Crosshair and Overlay Image Tools](#).

Creating and Using Feature Overlays

Feature overlays can be created for quick, on the fly evaluations of part features within the field of view. A visual comparison can be made between the specified overlay dimensions, and the part characteristics displayed in the Live Video window. Circle, line, arc, angle, slot, and rectangle feature types are supported.

Creating a Feature Overlay

Feature overlays are generated using the standard M3 **create feature function** using the procedure shown in the following example of a rectangle feature overlay:

1) Select the measure feature type (and sub-type) from the Measure toolbar that corresponds to the feature type that you would like to create. In this example the rectangle type is selected from the Measure Slot sub-menu.



2) Select the Create Feature button from the Measure Rectangle toolbar.

Digital Comparator and Profile Fit Software User's Guide

3) Enter the desired position, size, and orientation parameters for the feature to be created and set Create for overlay to Yes. If desired, specify a tolerance zone to be included in the overlay graphic. Press Done to complete the feature overlay. The overlay will be shown in the Live Video window.

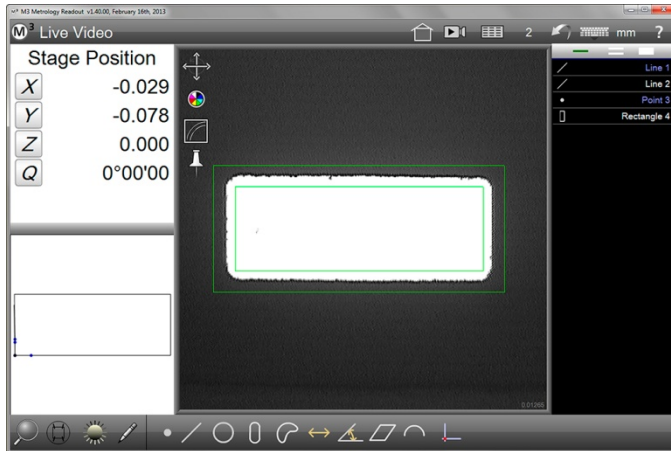

Create Rectangle	
X1	<input type="text" value="0.000"/>
Y1	<input type="text" value="0.000"/>
Z1	<input type="text" value="0.000"/>
X2	<input type="text" value="3.800"/>
Y2	<input type="text" value="0.000"/>
Z2	<input type="text" value="0.000"/>
W	<input type="text" value="0.75"/>
Create for overlay	<input checked="" type="checkbox"/> Yes
Overlay tol zone	<input type="text" value="0.150"/>

Notes

The coefficient entry fields displayed will be based upon the feature type you are creating. Only relevant feature coefficients can be defined for a given feature type (See the following feature overlay information).

If you are not satisfied with the feature overlay that you have created, simply start this process again from the beginning. The existing overlay will be replaced by the new one.

Line Overlay

X, Y, Z: X/Y/Z Line Start Position
A: Line Angle
L: Line Length

Circle Overlay

X, Y, Z: X/Y/Z Circle Position
D: Circle Diameter

Slot Overlay

X1/2, Y1/2, Z1/2: X/Y/Z Slot Start and End Position
R: Slot Radius

Rectangle Overlay

X1/2, Y1/2, Z1/2: X/Y/Z Rectangle Start and End Position
W: Rectangle Width

Angle Overlay

X, Y, Z: X/Y/Z Angle Apex Position
R: Angle Leg Length
SA/EA: Start Angle and End Angle

A dashed line will also be displayed for angle overlay features representing the nominal angle position and size.

Using a Feature Overlay

Once the feature overlay has been created, the overlay will be displayed in the Live Video window and the DXF tool buttons will be displayed in the top left corner of the window. Feature overlays can be manipulated in the Live Video window as described earlier in the section: [Video Window Crosshair and Overlay Image Tools](#). To use the feature overlay:

- 1) Use the overlay image tools in the top left corner of the Live Video window to:
 - Position the overlay over the target feature
 - Rotate the overlay if necessary for alignment
 - Select the desired color of the overlay
 - Enable or disable tolerance zone error whiskers
 - Place the overlay in the Part mode or the Screen mode

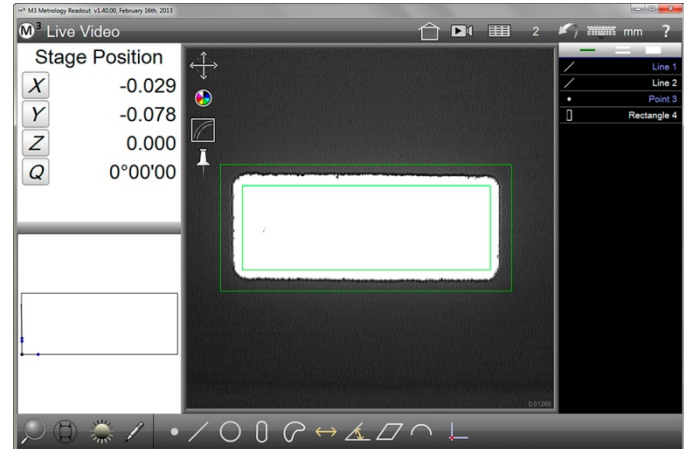

Overlay aligned over part feature

Some examples of feature overlay use are shown below:

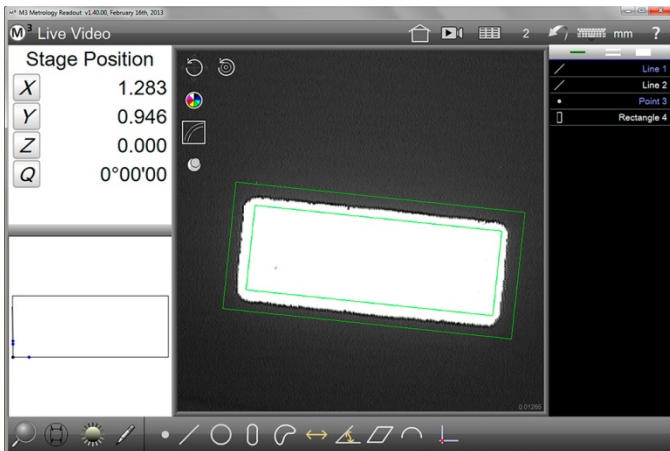

Overlay rotated for part alignment

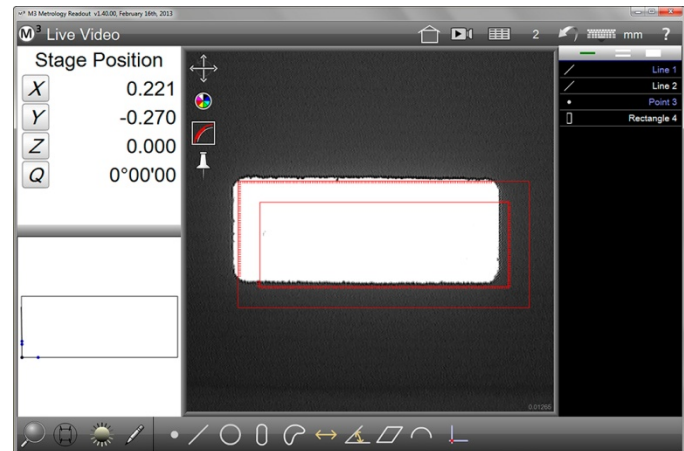

Error whiskers indicate tolerance failures

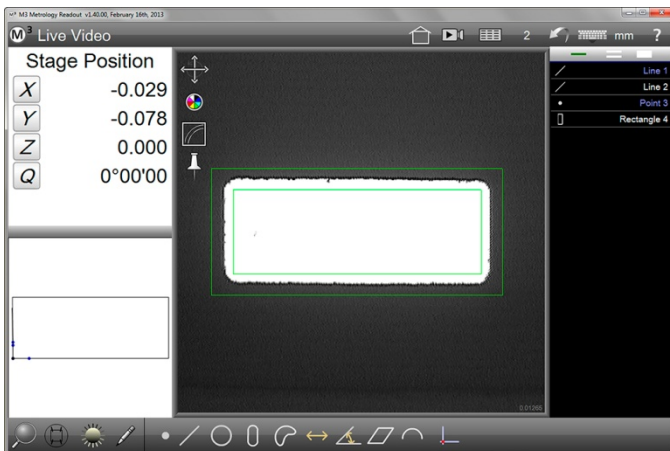

Part and stage in original position

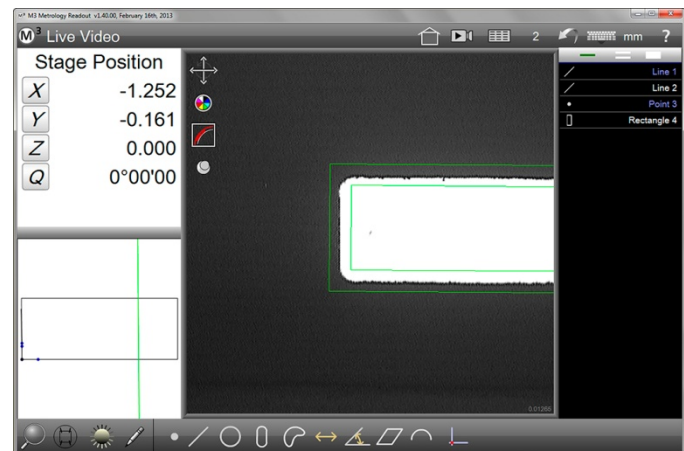

Overlay pinned in the Part Mode

Creating and Using DXF Overlays

Standard 2D DXF drawing files are converted and displayed in the Live Video window and part view as DXF overlays. Determining nominal fit of part features against an engineering drawing is facilitated by the display of red error whiskers. Violations of a user-defined tolerance zone can be viewed on screen and positional and angular overlay offset can quickly be calculated using the measure distance and measure angle functions.

Creating DXF Overlays

This section includes the following topics:

- Importing DXF Files
- Constructing Profile Features for DXF Overlays
- Applying Tolerance Zones to Profile Features
- Converting and Saving Profile Features as DXF Overlays
- Converting DXF Profile Features to Digital Comparator Overlay Files

Importing DXF Files

Importing standard 2D DXF part drawing files is the first step in the process of creating a DXF overlay. To import a DXF file:

- 1) Press the M3 logo to display the System Menu.
- 2) Press the Open File button to display the Open Part File dialog window.
- 3) Press the File Type button and select DXF File (*.DXF).
- 4) Use the dialog window Explorer functions to locate and select the desired DXF file.

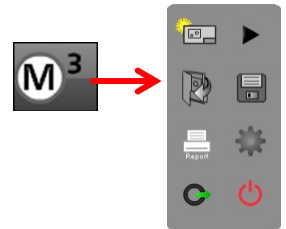

DXF files can be imported in either inch or millimeter units of measure. The choice of units can be specified by changing the part name to include or omit the string !IN! for inch units and !MM! for mm units.

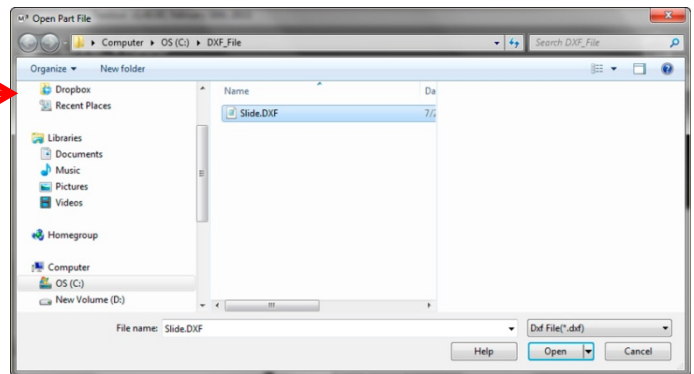
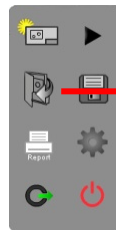

Filename.dxf

Imports the DXF part file to the center of screen's current field of view as the screen zero for the overlay. This will display the zero origin of the overlay file at the center of the field of view, regardless of any currently established part datum.

Filename!IN!

Imports the DXF part file with inch as the unit of measure.

Filename!MM!

Imports the DXF part file with millimeter as the unit of measure.

- 5) If you choose to import the DXF part file and force units of measure, right-click the file name in the Open File dialog and change the name to include the !IN! or !MM! string as described above. Otherwise, leave the file name unchanged.

Digital Comparator and Profile Fit Software User's Guide

6) Press the Open button to open the DXF file. The Import DXF dialog will be displayed. Choose from the following options:

- **Layers:** Set Layers to Yes to display or No to omit DXF layers
- **Units:** Set Units to mm or Inches
- **Scale:** Enter the desired scaling factor using the green keypad that appears when the Scale field is pressed or the computer keyboard
- **Mirror:** Set Mirror to X-Axis, Y-Axis or Both for mirroring. Set Mirror to No to omit DXF mirroring.



7) Press Done to import the DXF file. The part will be shown in the Part View window and the DXF part entities will be contained in the Feature List.

8) Press the Part View window at the lower left to display the imported DXF part entities in the large center window.

Note

*If the reference datum for the imported part DXF file is in the same location as the part datum, skip the following datum modification steps and proceed directly to **Constructing Profile Features**. If the datum for the imported DXF file is not at the part datum, perform the following datum modification steps.*

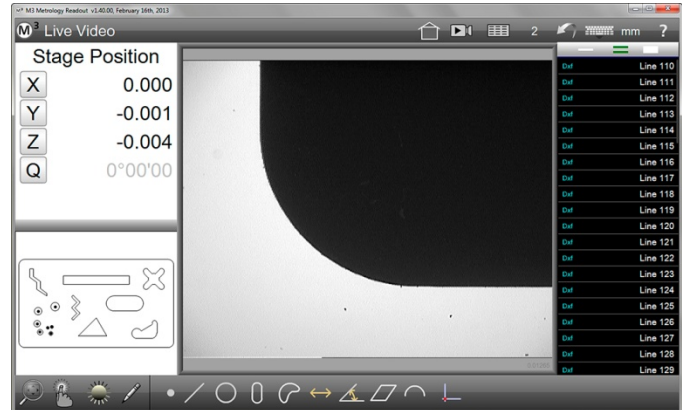

Moving the Datum Location of imported DXF Part File

The datum location of DXF part files can be modified to be consistent with the datum location of measured parts. To modify the DXF datum location:

- 1) Import the DXF file for overlay construction as described earlier. Often the zero datum position of a DXF part file is positioned away from the screen datum as shown in this example.
- 2) Press the Measure Datum button and then select the bottom horizontal and left vertical lines on the part.
- 3) Press Done. The datum will now be relocated to the bottom left corner of the part.

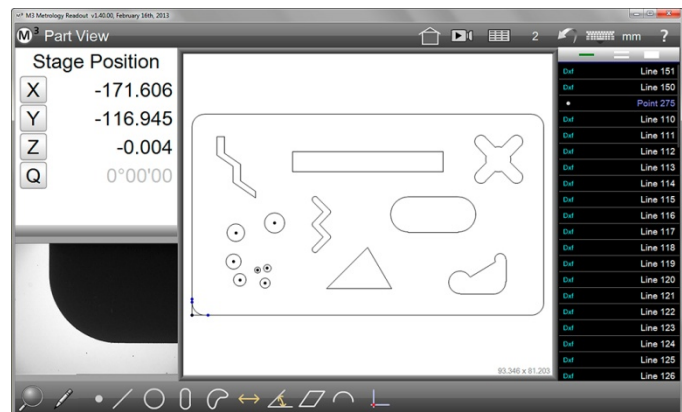
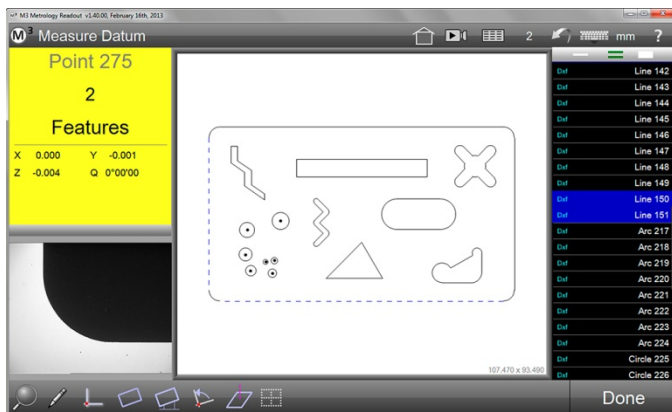
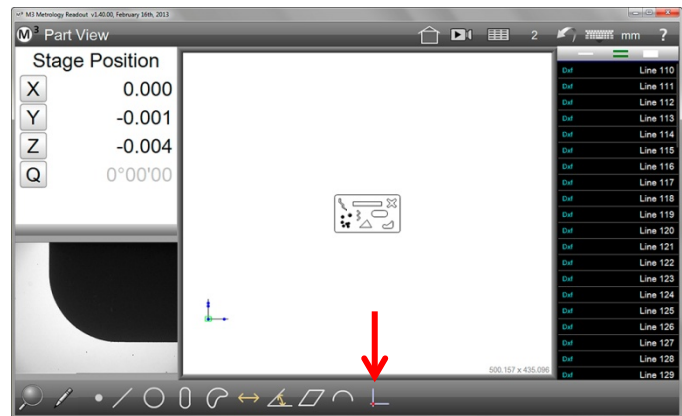

Note

Modifying the datum creates a non-DXF point feature in the Feature List. Remove this point before constructing profile features as described next.

Constructing Profile Features

Profile features group DXF entities together for the assignment of tolerance zones and material conditions that are necessary in DXF part overlays.

1) Use the M3 selection techniques to select and delete any DXF entities that will not be included in the final part overlay. If the datum location was changed after importing the DXF file, remove the point feature that was created in the Feature List as part of the process.

2) Press the Measure Profile button in the Measure Toolbar.



3) Profile features can be constructed from a single DXF entity, or from a group of DXF entities. The process is identical in either case. Select a DXF entity or a group of DXF entities for conversion by either:

- Pressing and dragging around an entity or group of entities in the Part View Window
- Selecting the DXF entity name(s) in the Feature List

4) Press Done to complete the conversion. The profile feature(s) will be displayed in blue in the Part View and will be added to the Feature List. In the example below, all entities of a test slide are converted to one profile feature.

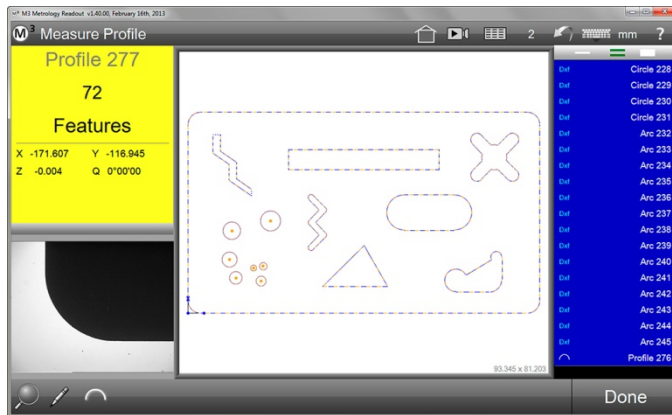

Five entities are selected

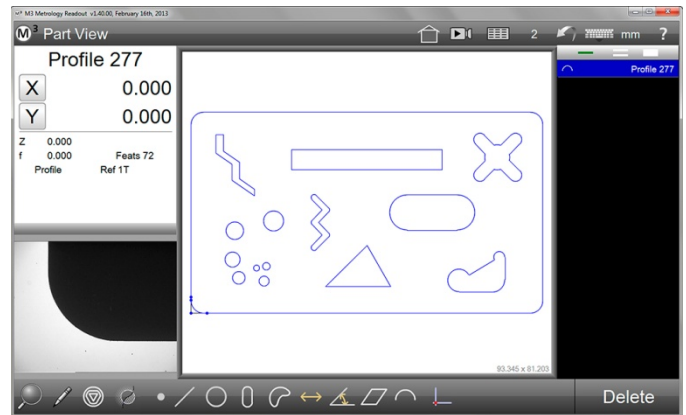

One profile feature is constructed

Once the required profile features have been constructed, tolerance zones can be applied.

Note

Single profile features can have only one tolerance zone, even if the profile feature was constructed of multiple DXF part entities. If different tolerance zones are required, separate profile features should be constructed.

Applying Tolerance Zones to Profile Features

To assign a +/- tolerance zone to a single profile feature or to a group of profile features:

1) Select a single profile feature or a group of profile features that will be assigned identical tolerances by either:

- Pressing and dragging around the features in the Part View window
- Selecting profile feature name(s) in the Feature List

2) Press the Feature Detail window in the upper left to display the large feature detail view. By default, the Tolerance Entry window will be displayed.

Digital Comparator and Profile Fit Software User's Guide

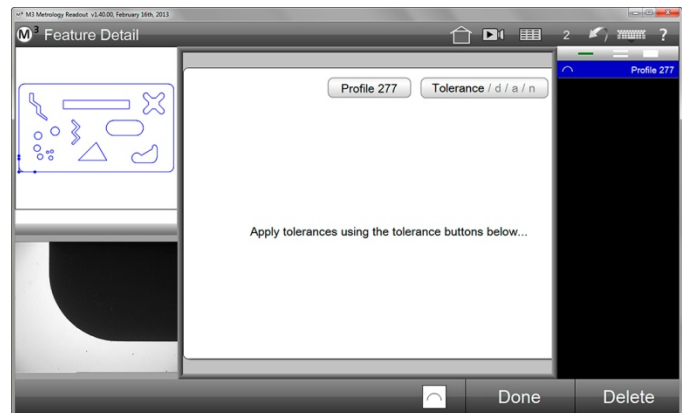
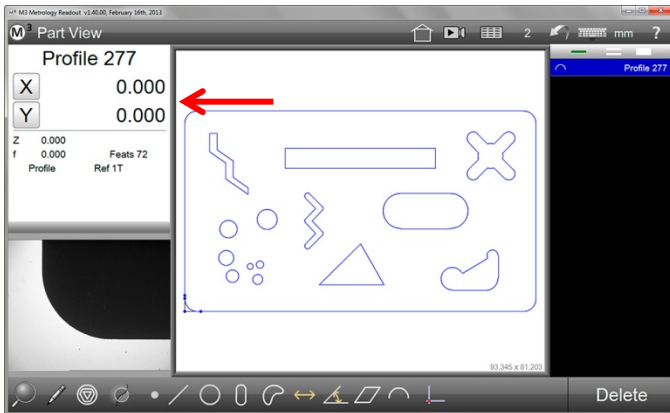

3) Press the Profile Tolerance button in the bottom toolbar to display the plus and minus tolerance zone data fields.

4) Press each field and enter the desired tolerance zone values, then press Done twice. The tolerance deviation window will be shown with the tolerance zones attached to the features and no deviation.

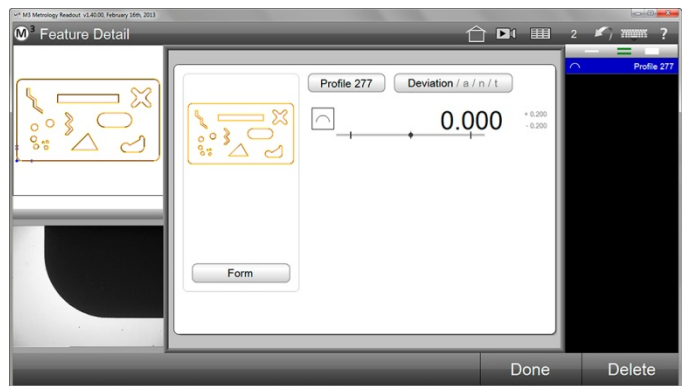
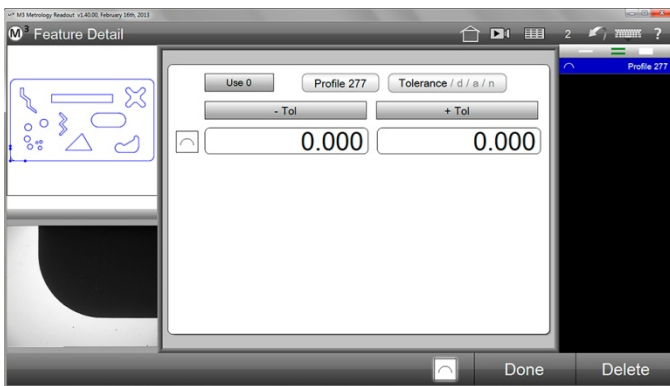

Note
When equal +/- tolerances will be applied, press the Use button after entering the first tolerance value. When unequal +/- tolerances will be applied, the individual plus and minus values must be entered separately.

5) Press Done again. The profile will be shown in the Part View window with the tolerance zones displayed around the nominal values of the profile feature.

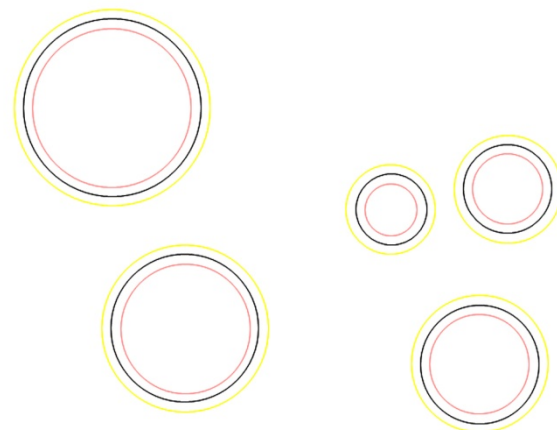
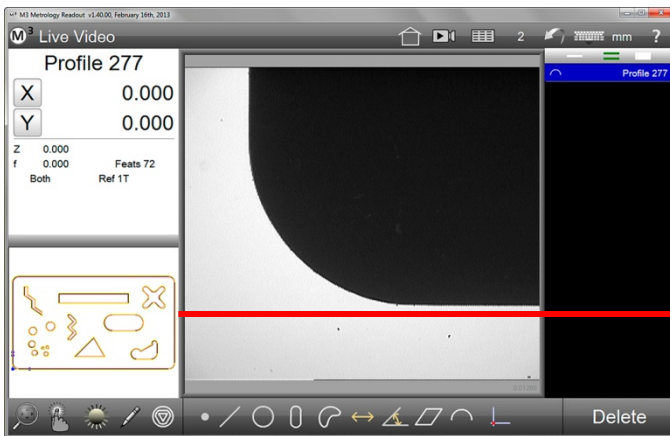

Five magnified circles of the slide

Digital Comparator and Profile Fit Software User's Guide

Assigning Material Conditions to Profile Tolerance Zones

Material conditions are applied to +/- tolerance zone values to facilitate the visual inspection of boss and bore part features using the Change Type and Edges functions. To assign material conditions to tolerance zones:

- 1) Once tolerances have been assigned to profile features, select the profile feature in the Feature List and then press the part view to move it to the center window.
- 2) Press the Change Type button in the Measure toolbar repeatedly to cycle through the part view displays of:

- Nominal part values
- Tolerance zone
- Both

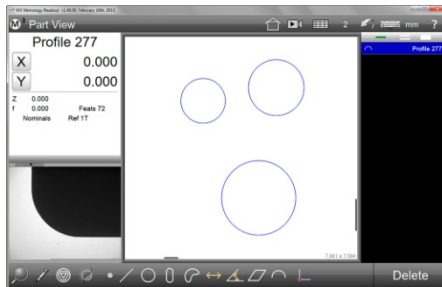
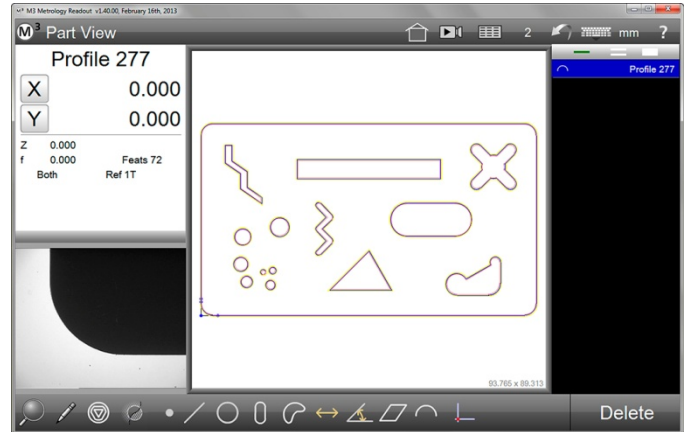

Nominal

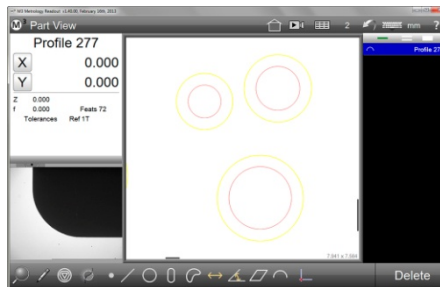

Tolerance Zone

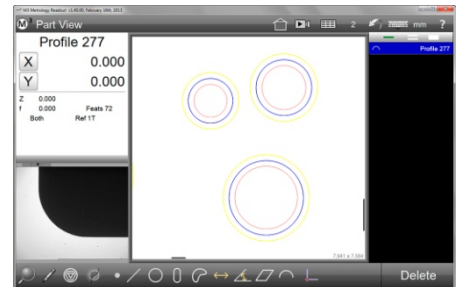

Both

Select to the desired presentation. The examples below will show a magnified portion of a part with both nominal and tolerance zones.

- 3) Since the minus tolerance is shown as the dark color, and the plus tolerance is shown as the light color:
 - Internal (bore) features should show dark on the inside (minus tolerance)
 - External (boss) features should show light on the outside (plus tolerance)



- 4) Change the plus and minus tolerance orientations of all features simultaneously by long-pressing the Edges button.

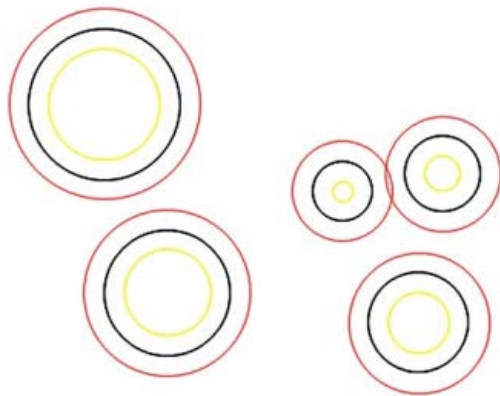

Plus tolerances outside

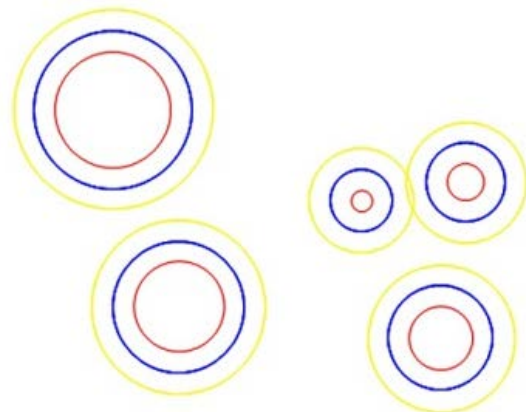

Plus tolerances inside

Digital Comparator and Profile Fit Software User's Guide

5) Change the plus and minus orientation of a single feature by pressing the Edges button to display it in orange and then pressing the feature you wish to change.

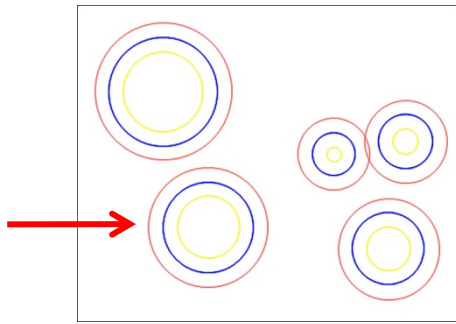

Initial minus tolerance outside

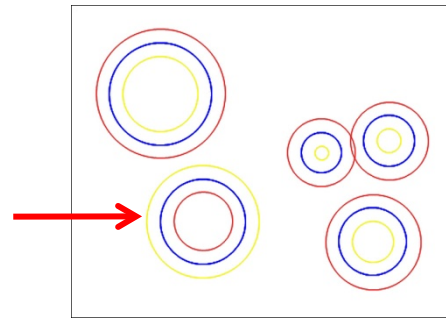

Changed to minus tolerance inside

Saving Profile Features as DXF Overlays

DXF overlay files are saved with all the tolerance and material assignments performed as described earlier. When the DXF overlay file is displayed in the Live Video window, all tolerance zone and material assignments will be shown as well.

To save the DXF profiles as a DXF overlay file:

1) Press the Report button in the top toolbar to display the Report View.



2) Press the Export button in the Report Toolbar to display the Export menu, and then press DXF in the Export Menu. The Save File dialog will be displayed.

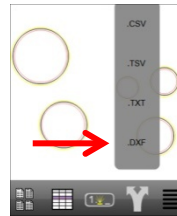

3) Assign a name to the DXF file and save it to the desired location.

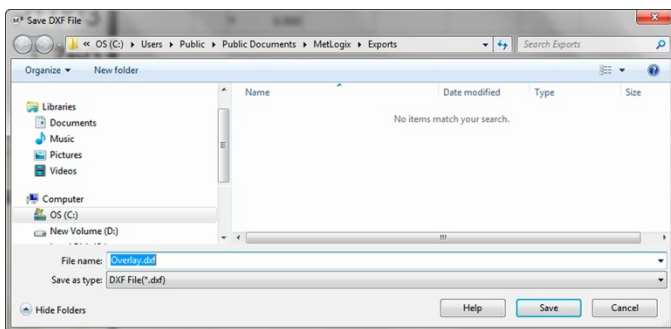
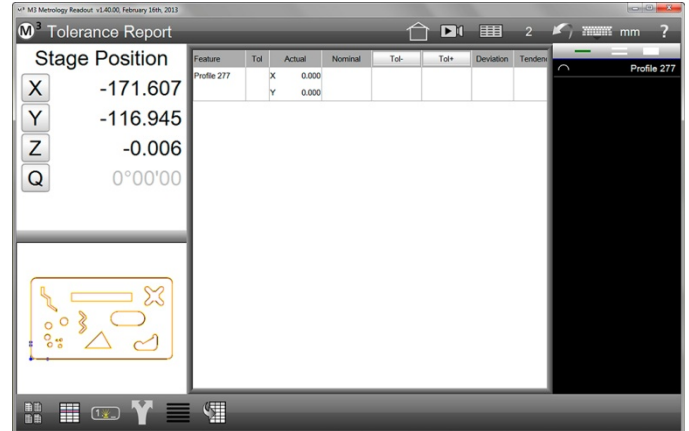

Converting Profile Features to Digital Comparator Overlays

Profile features are converted to DXF digital comparator overlay files as follows:

- 1) Press the Home button to display the Live Video window in the center window. 
- 2) Select the profile feature(s) in the Feature List, press the Probe button in the Measure menu and then select the DXF probe from the Probe menu. The DXF probe tools will appear in the left-top of the Live Video window.

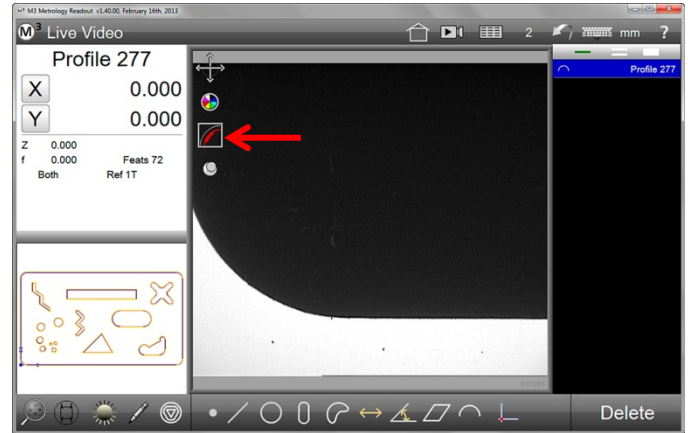
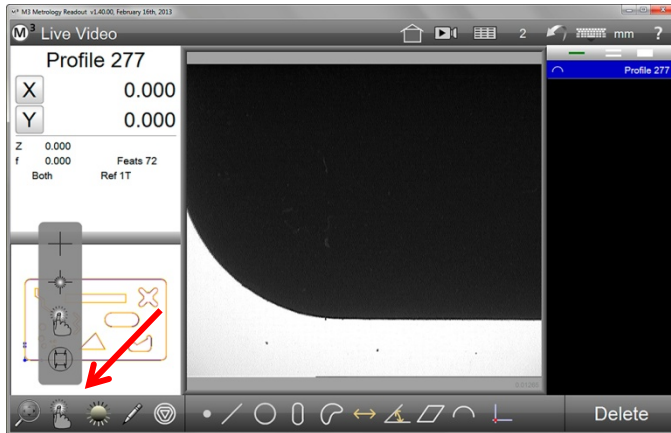

- 3) With the profile feature(s) selected in the Feature list, long-press the DXF Probe button in the Measure toolbar. This action will convert the selected profile feature(s) to a digital comparator overlay.
- 4) Zoom out using the mouse wheel until the small overlay is visible and then click and drag the overlay to superimpose it over the part.

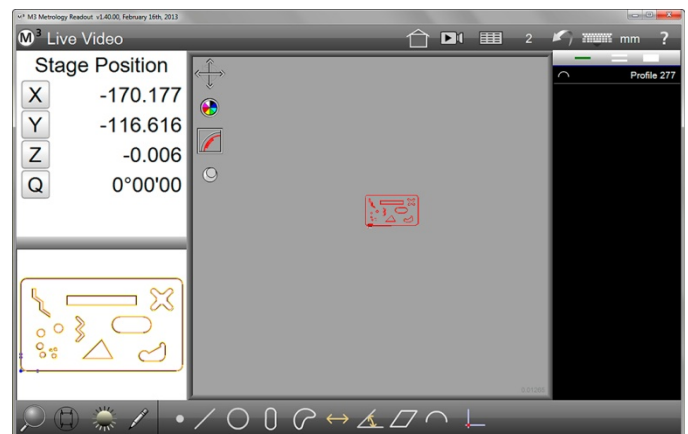
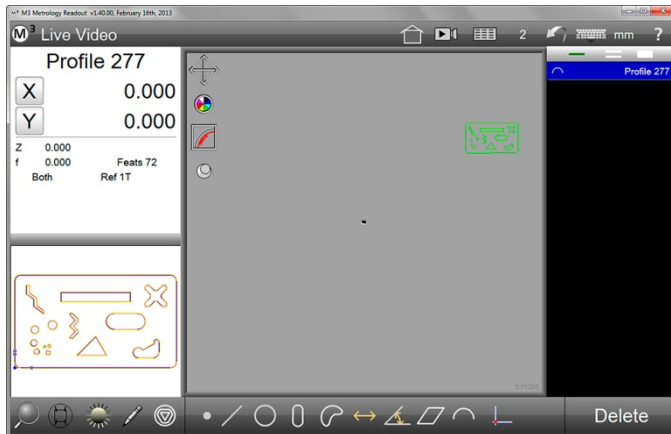

- 5) Zoom up on the part and overlay to fill the Part View screen and then complete the overlay alignment.

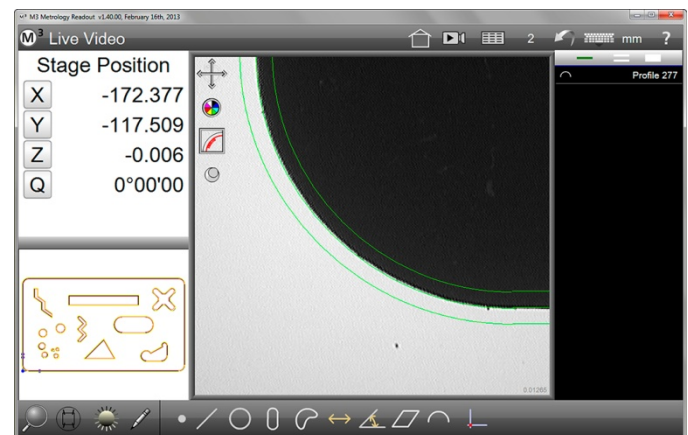
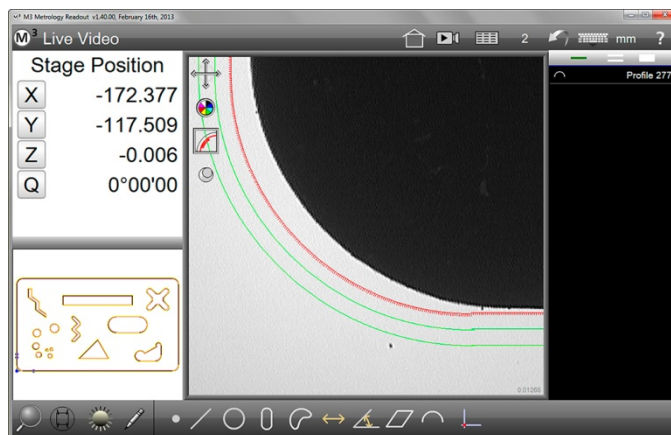

Digital Comparator and Profile Fit Software User's Guide

Using DXF Overlays

Once the DXF overlay has been created or opened, the overlay will be displayed in the Live Video window and the DXF tool buttons will be displayed in the top left corner of the window. Overlays can be manipulated in the Live Video window as described earlier in the section: [Video Window Crosshair and Overlay Image Tools](#). To use the DXF overlay:

Use the overlay image tools in the top left corner of the Live Video window to:

- Position the overlay over the target feature
- Rotate the overlay if necessary for alignment
- Select the desired color of the overlay
- Enable or disable tolerance zone error whiskers
- Place the overlay in the Part mode or the Screen mode

Opening an Existing DXF Overlay

To open a DXF overlay:

- 1) Long-press the DXF Probe button in the Measure toolbar. The Open DXF File dialog will be displayed.
- 2) Locate and select the desired overlay file and then press Open. The overlay will be displayed in the Live Video window.

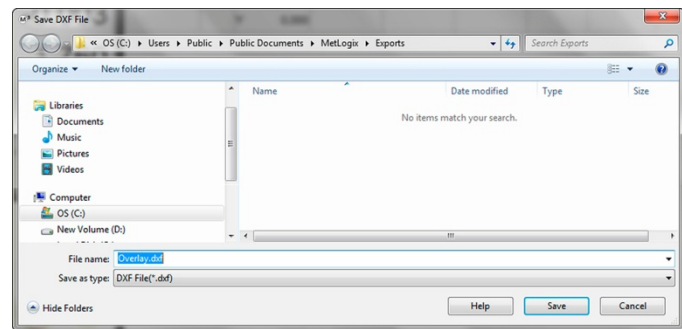

Note

Digital overlays can be shifted and rotated to optimize alignment with the part being inspected. These overlay display manipulations are best performed when the DXF overlay datum position is the same as the part datum position. If the overlay datum position requires modification, return to the [Moving the Datum Location of imported DXF Part File](#) section described earlier in this guide.

Manipulating DXF Overlays

Overlays can be manipulated in the Live Video window as described earlier in the section: [Video Window Crosshair and Overlay Image Tools](#).

Measuring Overlay Offset

The positional and angular offset between the DXF overlay and the M3 current part coordinate system can be calculated by the system. The offset is determined by performing iterative distance and angle measurements while the overlay is displayed above the part.

Note

The part coordinate system and datum must be registered and the overlay DXF file must include a matching datum and coordinate system.

To measure overlay offsets:

- 1) Once the part coordinate system is registered and the overlay has been imported, toggle the Push Pin to the part mode.



The overlay will be positioned over the part in the part coordinate system. It is likely that the overlay position is nearly coincident with the part but can be improved using the Pan/Rotate functions.

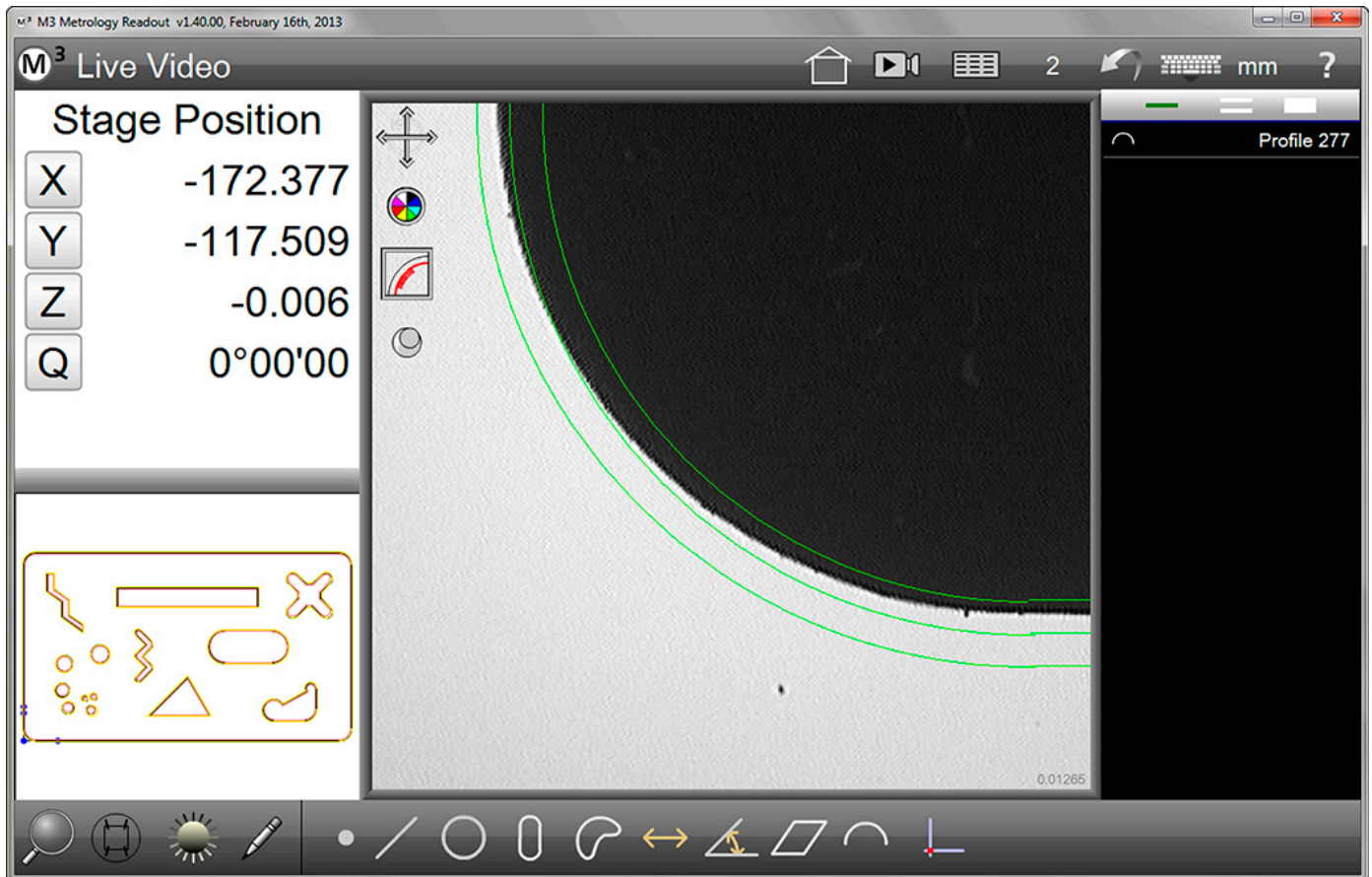

- 2) Use a combination of panning and rotating the overlay image to optimize the overlay and part alignment. This will be an iterative process of:

- Toggling the Pan/Rotate button to Pan and improving the XY overlay alignment
- Toggling the Pan/Rotate button to Rotate and improving the angular alignment

Note

Use the keyboard arrow keys to make fine XY translation and rotational alignments.

Digital Comparator and Profile Fit Software User's Guide

3) When the overlay and part alignment has been optimized, press the Measure Distance button in the Measure toolbar and then press Done. The distance offset feature will be added to the Feature List and shown in the Part View window.

4) Press the Measure Angle button in the Measure toolbar and then press Done. The angular offset feature will be added to the Feature List and shown in the Part View window.

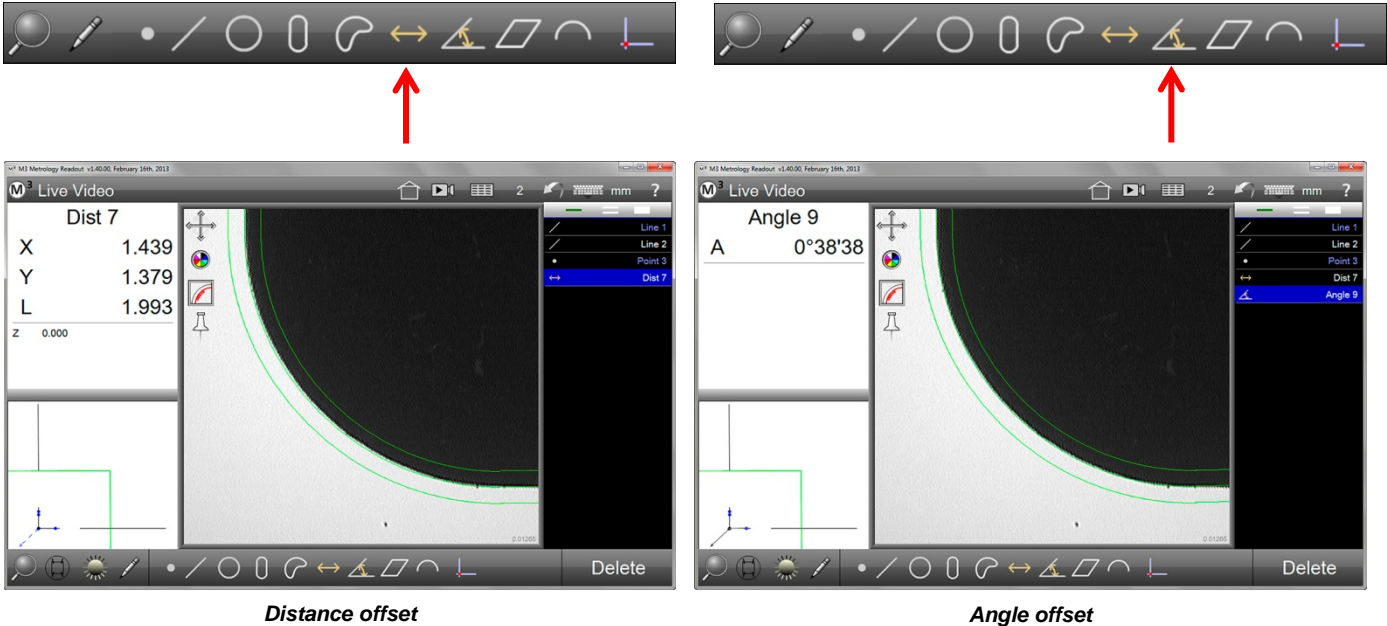

Exporting Features as DXF Files

Measured, constructed and created features can be exported from the M3 software as a DXF file for use with third-party applications or for re-import to the M3 software. To export the contents of the Feature List as a DXF file:

1) Conduct part measurements to populate the Feature List with the desired features for export.

2) Press the Report button in the top toolbar to display the report view window.

3) Press the Export button in the Measure toolbar to display the Export menu, and then select DXF.

4) Select the desired location for the DXF export file from the Windows dialog box and then press Save.

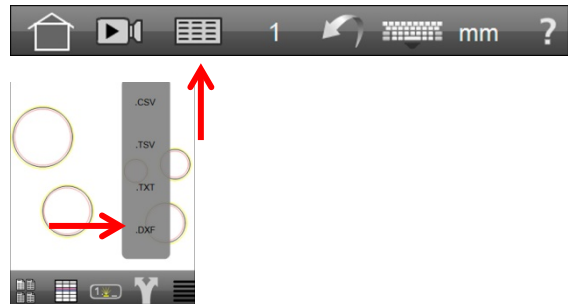

Pattern Recognition and Program Playback

The M3 pattern recognition function teaches specific image patterns to the system for automatic detection during program playback. Program playback can be improved using a soft-fixture based part alignment routine, utilizing this pattern detection mechanism.

Patterns can be measured, or taught, as datum patterns where the skew and zero positions are set automatically or as standard pattern features where the part or machine coordinate pattern position and orientation are reported for the pattern feature.

Teaching a pattern

Select the desired pattern to be used for detection in playback. Ideal candidate patterns should contain image characteristics that are unique relative to the rest of the field of view in which they are taught. In addition, target pattern regions should contain reasonable light to dark pixel contrast and be relatively free of image noise and distortion.

To teach a pattern:

- 1) With the desired pattern in the field of view, press the Datum button in the Measure Toolbar to display the Datum Pattern Menu.

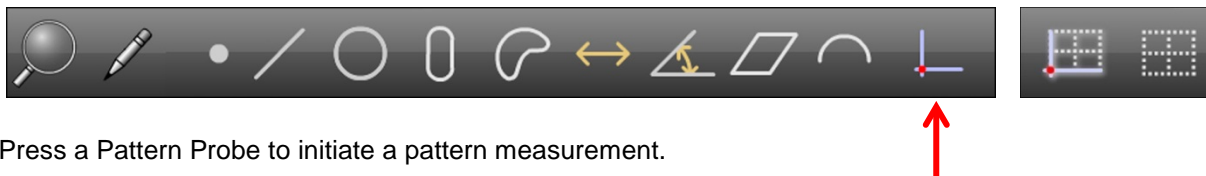

- 2) Press a Pattern Probe to initiate a pattern measurement.

There are two pattern measurement types:

- Datum pattern measurement (default type)
- Standard pattern measurement

Datum Pattern Measurement

This is the default pattern measurement and sets the measured pattern feature to $XY=0$ and $\text{angle}=0$. To measure (or teach) a datum pattern:

- 1) With the Measure Datum Pattern tool selected (default), press and drag to completely enclose the desired pattern. The pattern feature will be shown in the Feature List, and the pattern position and angle will be shown in the detail view, with position and angle set to zero. The pattern will be registered for Program playback as shown in the Part View, and other features can be probed.

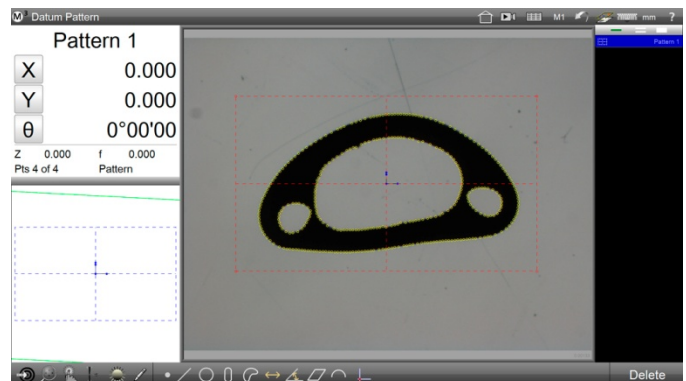
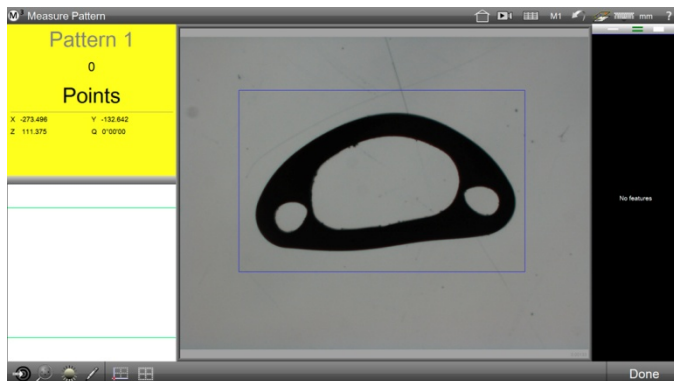

Standard Pattern Measurement

To perform a standard pattern measurement (teach):

- 1) Select the Standard Pattern Tool and then press and drag to completely enclose the desired pattern.

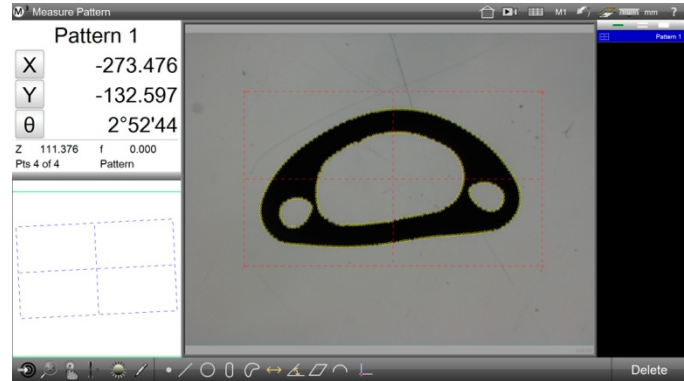
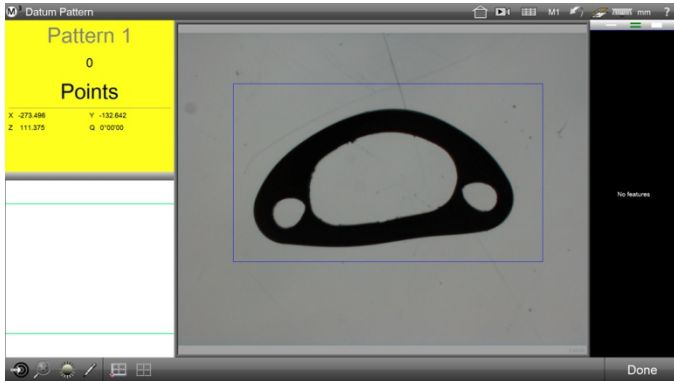

The pattern will be shown in the feature list, and the current stage position and angle will be shown in the detailed view window.

Note

Standard pattern features are typically used when a datum alignment will be constructed from two or more pattern features.

Pattern Program Playback

Once a fully registered datum pattern has been measured (taught) and other features have been probed, the measuring program can be played back. To play the program:

- 1) Position the datum pattern anywhere in the field of view and then press anywhere in the Live Video window to execute the program. The program will recognize the datum pattern, register the coordinate system and measure any remaining features.

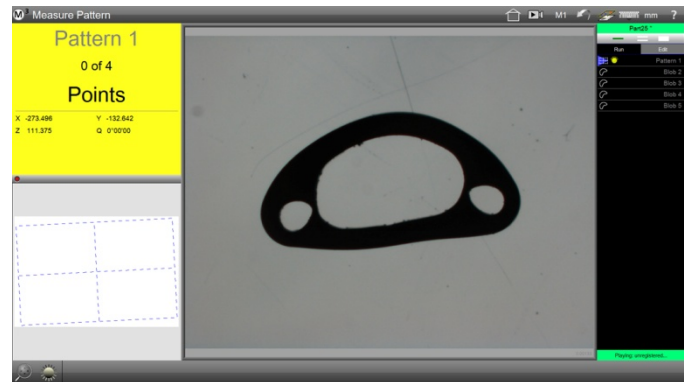

Note

In CNC-enabled systems, a message will be displayed asking for playback confirmation prior to any potential stage movement.

Important note for CNC-enabled systems

The angle of a given pattern is used as a temporary skew in program playback. Because the repeatability of the pattern angle is good only to 1°, subsequent features, particularly when located far from the initial pattern, may not be found automatically. To use the pattern finder most effectively in this case, choose an initial pattern that is located as close to the intended datum features as possible.

Viewing the Image Source for Pattern Features

For any measured (taught) pattern feature, the large feature detail screen can be used to view the originally sampled image of a given pattern.

Select the pattern feature from the Feature List that you would like to view, press in the small feature detail window at the top left of your screen to access the large feature detail window. The original image sample will be displayed for the selected pattern.

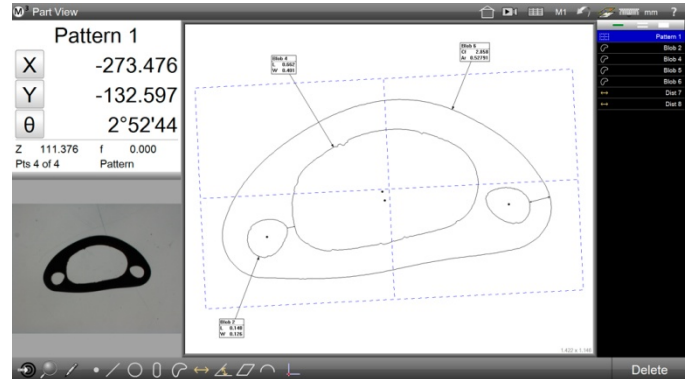

Freezing Live Video Images

The field of view option provides the capability to quickly freeze and release a live video image within the M3 software. All M3 features and functions remain available whether the camera image is static or live. To freeze a live video image:

1) Press the pause image button  found in the top right toolbar to freeze the current Live Video window image in the field of view.

2) Press the Play Image button  to resume the live image feed.

Profile Fit Functions

Profile fit functions are extensions of the profile and overlay functions described earlier in this guide and of the general measurement functions of the M3V2 software. Since the use of profile fit functions rely heavily on an understanding of basic M3 and optional digital comparator operations, be sure that you are familiar with the M3V2 software and earlier digital comparator portions of this guide before proceeding.

Terminology/Nomenclature

Profile measurement is a new optional function supported by the M3V2 software. Profiling uses fitting routines to compare measured part data points to the nominal part parameters and tolerances included in a CAD files. Profiling creates a **Profile feature** that is displayed in the Part View and entered into the Feature List. Profiling results can be annotated and reported. Profiling can also be included in part programs.

Part profiles are measured using the **Profile Tool**. The profile tool is created from an existing **Constructed Profile** or from a .dxf file using one of three work-flows. The workflow chosen will depend on the current state of the .dxf file and the goals and requirements of the measurement application.

The controls used to modify **Fit Parameters** are available in the **Profile Measure** toolbar and **Profile Settings** dialog. Press the Settings button to display the Profile Settings dialog. These fit controls include: independent **Fit Constraints (X,Y, A)**, **Fit Point Spacing**, **Fit Algorithm Selection**, and **Fit Point Filtering**.

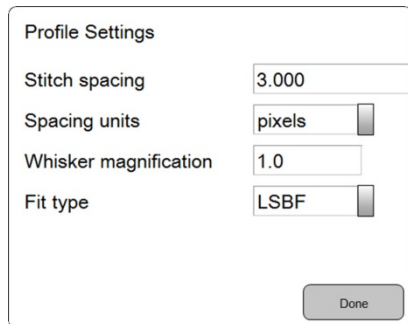
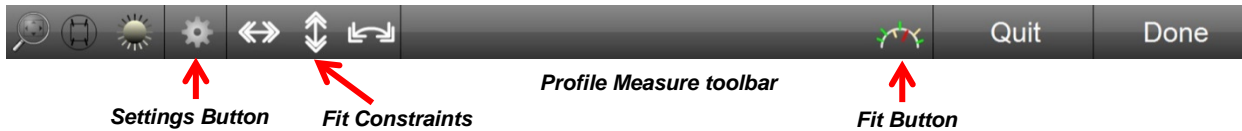

Profile Settings Dialog

Perform a profile measurement using the Fit button. Fit as many times as you would like prior to completing the profile measurement. Press Done to complete the measurement and exit the **Measure Profile** mode. The profile feature will be added to the Feature List.

A profile measurement result consists of the **Profile** result and its individual **Profile Whisker** results.

Profile and Profile Whisker result detail are displayed in the top left viewport by selecting the Profile Feature in the Feature List or by selecting individual whiskers in the Part View.

Profile Selection: (XYA, -T, +T,#Pts)

Profile 280			
X		-0.091	
Y		0.008	
A		-0°00'29	
-P	0.045	+P	0.068
f	0.114	Pts	247 of 247
Both		Ref	1T

Profile Result Detail

This profile result detail example is shown in red because at least one measured profile point exceeded the specified profile tolerance. The profile result detail of measurements within tolerance are shown in black.

The profile result data shows the profile shift in the X axis, Y axis, and theta angle (A) required to best fit the measured data points to the part CAD data. The plus and minus dimensional deviation, form error, number of measured points and measurement reference frame are also shown.

Digital Comparator and Profile Fit Software User's Guide

Whisker Selection: (Pt#,Delta,Tol, %Tol)

Profile 280	
X	-0.091
Y	0.008
A	-0°00'29
pt 165	Δ 0.036
Tol 0.025	T% 144

Whisker Result Detail

This whisker result detail example shows the point number in red because it exceeded the specified profile tolerance.

The whisker results data shows the coefficients of a of a single fit point selection. It includes the point number, Measurements equal to or less than 100% are within tolerance and shown in green or orange, measurements over 100% are out of tolerance and shown in red.

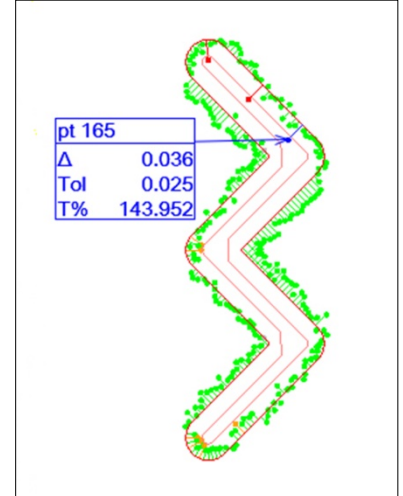

Annotated Whisker Result Detail

Selected whiskers can be annotated to show results in the part view. This example of an annotated whisker selection shows data for a point that exceeds the specified profile tolerance. The annotated result shows the Delta distance normal to the surface from the CAD profile model, the tolerance band size and the percentage of the tolerance band measured at the selected point.

Completed profile measurements can be evaluated in the Whisker Results of the part view using the Whisker Results Toolbar buttons.



- 1 Connect whisker result data annotations to whiskers selected in the part view
- 2 Show or hide whiskers in the part view
- 3 Decrease whisker magnification
- 4 Increase whisker magnification
- 5 Press to display profile measurement settings
- 6 Locate best whisker measurement
- 7 Locate worst whisker measurement
- 8 Rank worst whisker measurements

A profile measurement fails when any of its whiskers are outside the + or – tolerance zone. The tolerance zone is specified initially from the dxf, but can be changed for a measured profile by editing the tolerance in the Profile Feature detail screen.

NOTE

Only uniform tolerances can be edited. Non-uniform profile tolerances cannot be edited and will be displayed in the feature detail screen as “Varies”.

Digital Comparator and Profile Fit Software User's Guide

Operation

Any one of three workflow methods can be used to perform profile measurements. An understanding of .dxf file preparation is required to perform profile measurements. The fundamentals of .dxf file preparation can be found in the earlier Digital Comparator section of this manual.

Work Flow #1: Measuring a Profile Using a .dxf CAD File

To perform a profile measurement using a .dxf CAD file:

Note

Steps 1 through 5 are explained in the earlier Digital Comparator section of this guide.

- 1) Open the .dxf file containing nominal entities.
- 2) Set or modify the datum on the part file if applicable
- 3) Remove unnecessary entities
- 4) Construct the Profile feature from nominal entities
- 5) Assign tolerances from the feature detail screen. Tolerances can be equal or different bi-lateral tolerances. At this point you have constructed a profile with tolerances.

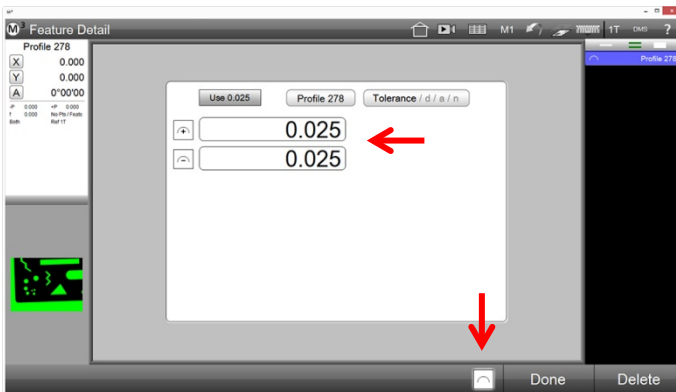

Press the Profile Tolerance button and enter tolerances

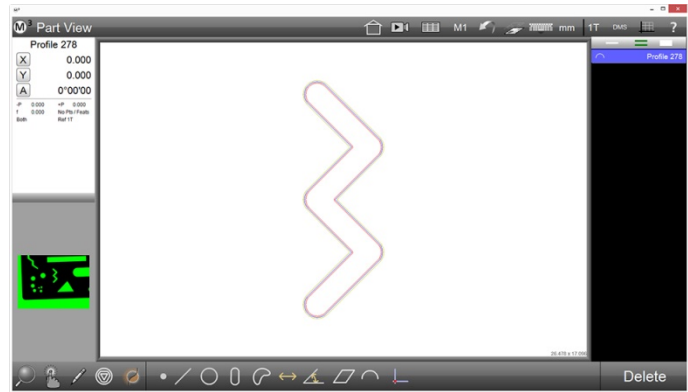

Tolerances will be displayed around the profile feature

- 6) Perform a profile measurement from the video window by pressing the Measure Profile button, then selecting the previously constructed Profile from the Feature List. The profile tool will be displayed in the Video Window. If the part datum matches the .dxf file datum, the profile tool will be positioned over the feature to be measured. If the part and .dxf datums are different, the tool will be positioned away from the feature to be measured.

- 7) Position the Profile tool over the profile to be measured and use the tool sizing handles to change the size of the tool. You can use the same DXF tools utilized in the Digital comparator function to position the tool and expand it to enclose the profile to be measured. When the profile is properly enclosed, the candidate data points will be shown in blue on the edge of the profile.

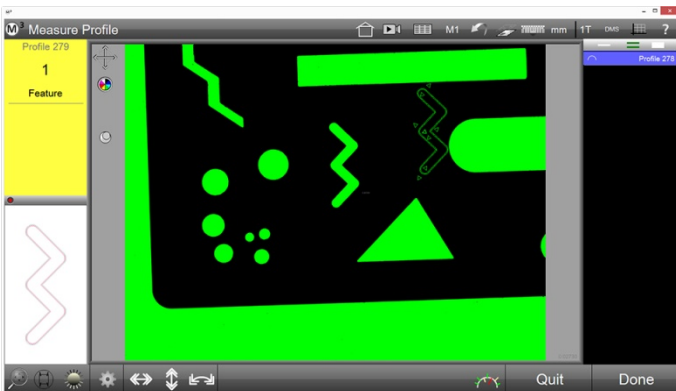

Profile tool in video window

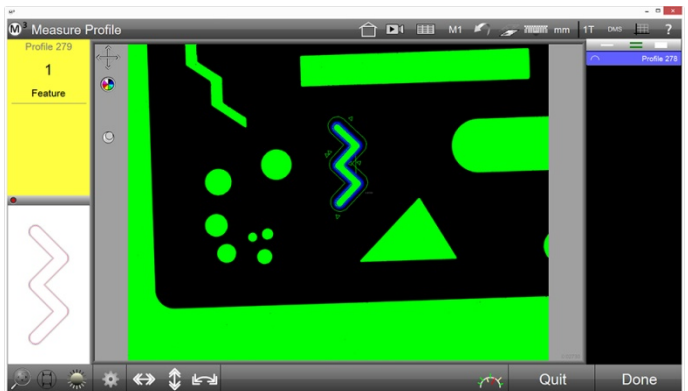

Profile tool positioned

Digital Comparator and Profile Fit Software User's Guide

8) Once the Profile tool is positioned and sized, press the Fit button to perform a profile fit operation. Perform as many fit operations as necessary to achieve the best fit and then press the Done button to complete the profile measurement. The Profile measurement results will be displayed in the upper left detail view. In this example, the results are shown in red because at least on point exceeded the specified tolerance.

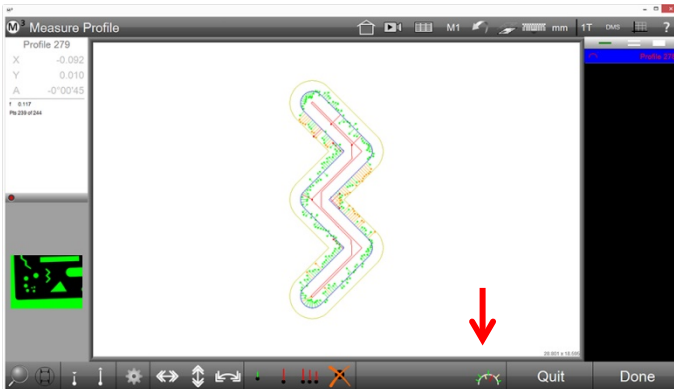

Fit operation performed

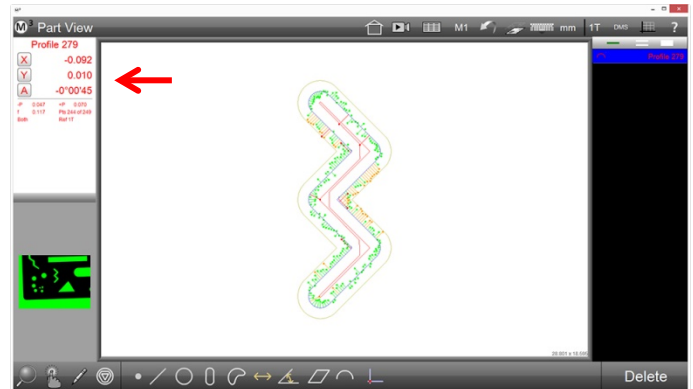

Profile measurement completed, results shown

9) Profile whiskers will be displayed in the center part view. Select a whisker to display whisker result details in the upper left detail view. The profile whisker graphic can be annotated using methods described earlier in the Main M3V2 user's guide.

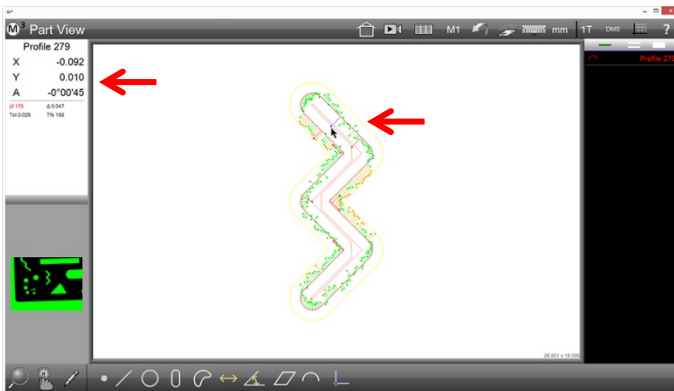

Select a whisker to show whisker results

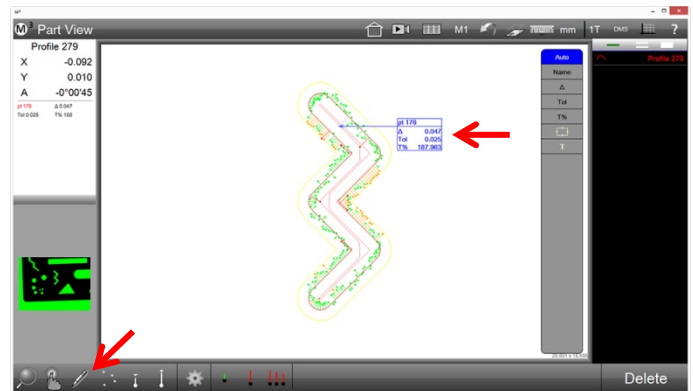

Annotated whisker result

Measuring a profile within a part program

To include a profile measurement in a part program:

- 1) Follow the steps discussed above in [Workflow #1](#) until you have a constructed Profile in your feature list.
- 2) Begin creating your part program starting with program registration features and continuing through the completion of the part.
- 3) When you are ready to perform a profile measurement, press the measure profile button and select the previously constructed profile from the feature list. When pressing Done to complete the profile measurement, you will see that the constructed profile is consumed by the profile measurement, and your part program should be correctly sequenced for normal registration.

Digital Comparator and Profile Fit Software User's Guide

Workflow #2: Converting a .dxf Overlay to a Profile Tool

To convert a .dxf overlay file to a profile tool:

Note

Step 1 is explained in the earlier Digital Comparator section of this guide.

- 1) Open the desired dxf overlay. A new Fit button will now appear in the upper left of the video screen
- 2) Position the overlay over the part and press the Fit button in the upper left portion of the video window. The overlay will now be converted to a Profile tool and candidate data points will be shown in blue. Press the Fit button in the Profile Measure toolbar to perform a fit operation.

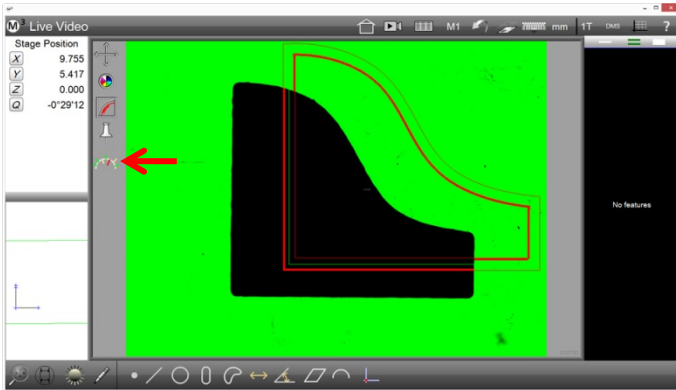

Import and position the .dxf overlay and then press the Fit button

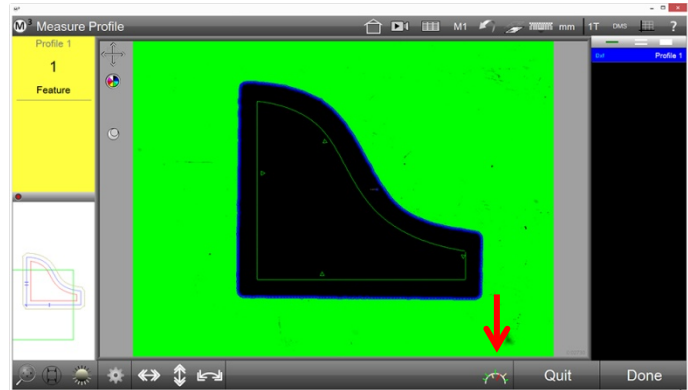

Candidate data points will be shown in blue, press the Fit button

- 3) Perform as many fit operations as necessary to achieve the best fit and then press the Done button to complete the profile measurement. The Profile measurement results will be displayed in the upper left detail view. In this example, the results are shown in red because at least one point exceeded the specified tolerance.

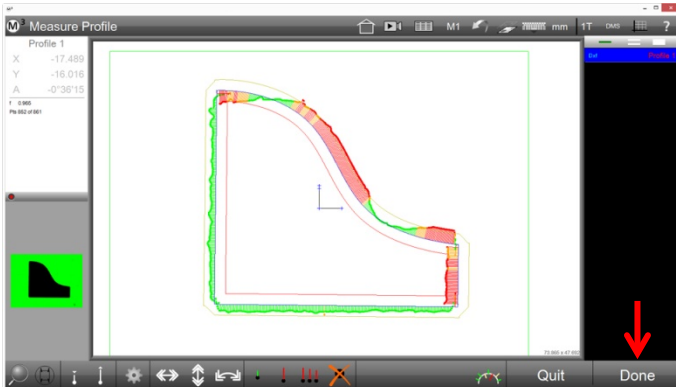

Fit operation performed



Profile measurement completed, results shown

Note

When using this method to create a Profile Tool, it can be used at any point during M3 program authoring. This is because the overlay has already been prepared and includes tolerancing and the dark/light layer assignment. Because the profile was created from an overlay, both the overlay and the profile steps are recorded in the program. Edit and delete steps as needed.

Digital Comparator and Profile Fit Software User's Guide

Workflow #3: Performing a profile Measurement Using a .dxf Overlay File

To perform a profile measurement using a .dxf overlay file:

Note

Preparing a .dxf overlay file, step 2 and step 3 are explained in the earlier Digital Comparator section of this guide.

- 1) Press the Measure Profile button to enter measure profile mode.
- 2) Import the desired .dxf overlay file. The overlay will be converted to a profile tool and shown in the video window.
- 3) Position the profile tool over the part to be measured and use the tool sizing handles to change the size of the tool. You can use the same DXF tools utilized in the Digital comparator function to position the tool and expand it to enclose the profile to be measured. When the profile is properly enclosed, the candidate data points will be shown in blue on the edge of the profile.

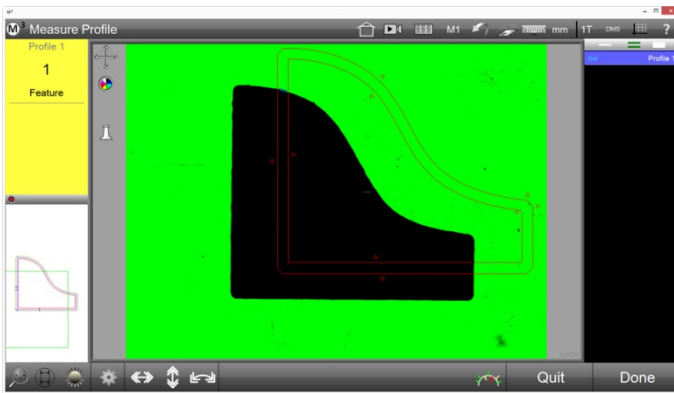

Profile tool in video window

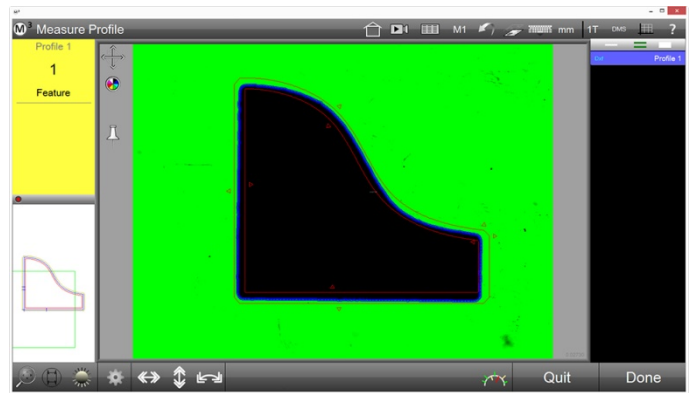

Profile tool positioned above part

- 4) Press the Fit button in the Profile Measure toolbar to perform a fit operation. Perform as many fit operations as necessary to achieve the best fit and then press the Done button to complete the profile measurement. The Profile measurement results will be displayed in the upper left detail view. In this example, the results are shown in red because at least on point exceeded the specified tolerance.

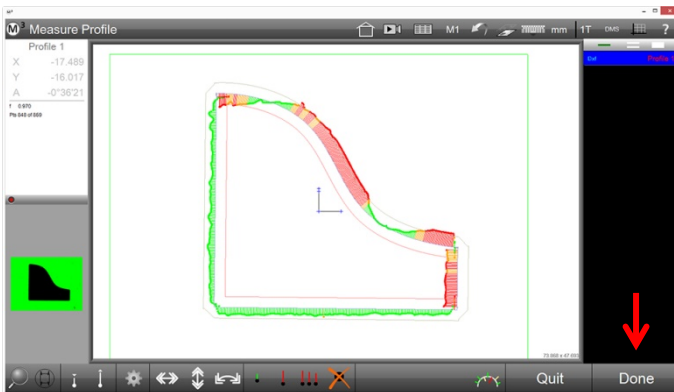

Fit operation performed



Profile measurement completed, results shown

Set up and miscellaneous functions

Setup and miscellaneous functions include:

- Profile settings
- Non-uniform tolerancing
- Edit and record into
- Profiling constraints
- Exporting the profile data cloud

Profile settings

Several settings are available in the Profile Settings dialog that can be used to modify the display of results and the fit algorithm of profile measurements. The Profile Settings dialog is displayed by pressing the Settings button of the Profile Results toolbar.

- Stitch spacing: the distance between points and whiskers on a profile
- Spacing units: the unit of measure (pixels, inches or mm) of stitch spacing
- Whisker magnification: a multiplier to lengthen or shorten the error whiskers
- Fit type: the fit algorithm used for profile measurements; LSBF (least squares best fit), or ATV (Admissible Transformational Volume)
 - LSBF focuses on fitting the nominal of the profile. The errors are squared with more weight given to outliers from the nominal
 - ATV is a fit algorithm that might be supported in the future, but is not supported in this release. The ATV fit allows more parts to pass a profile tolerance test by ignoring portions of the profile that are in tolerance and adjusting the fit using the portions nearly out or out of tolerance

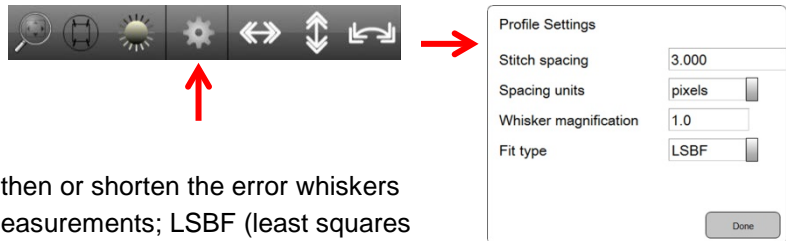

Non-uniform tolerancing

The M3 is capable of creating a profile tool from externally created DXF files that can contain non-uniform tolerances such as the Christmas tree slot. The M3 is not capable of creating non-uniform toleranced tools using the methods described earlier in the Digital Comparator portion of this guide. However, pre-prepared .dxf files containing non-uniform tolerance zones can be used to create profile tools used for profile measurement in the M3.

Edit and Record into

Profile features can be re-measured in program edit mode in the same manner as standard feature editing. Re-measure and program append will be supported for profile features in Edit mode. However, the tolerance value applied to a non-uniform profile measurement cannot be modified in edit mode.

Profiling Constraints

When free form profile measurements are performed without axis or rotation constraints, the profile measurement data cloud is shifted by the system in the X and Y axis, and rotated to optimize the profile fit. However, some applications might require one or more constraints that prohibit data cloud shifts in X-axis, Y-axis or rotation.

The example on the next page shows the results of two profile measurements of a part. The first is a free form measurement that allows the system to optimize the fit by shifting and rotating the data cloud when comparing measured points to the CAD data. The second is a constrained fit that prohibits shifting the data cloud of measured points in the X-axis. Any combination of constraints can be applied by disabling shift parameters prior to a fit operation. Press constraint buttons in the Measure profile toolbar to enable or disable data cloud constraints.

Digital Comparator and Profile Fit Software User's Guide

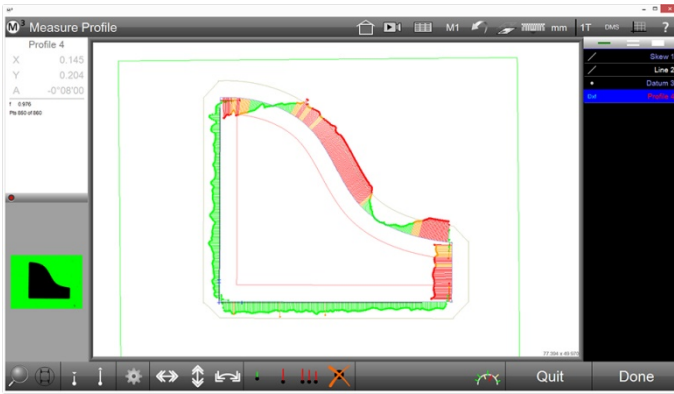

Free form fit; no constraints enabled

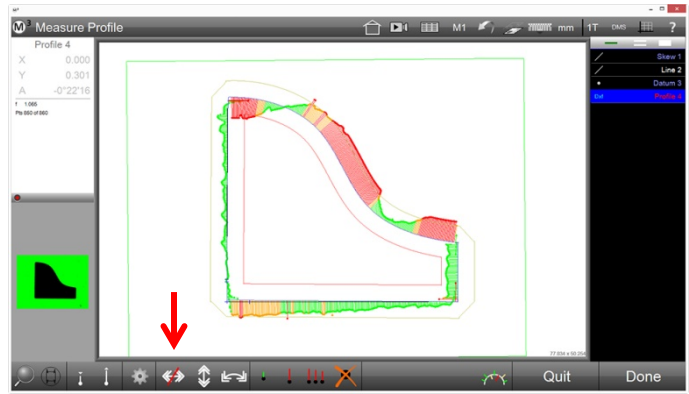

Constrained fit; X-axis data cloud shift constrained

Exporting Profile Measurement Data Cloud

To export the Data Cloud into an Excel or a CAD program:

- 1) Perform the desired fit.
- 2) Select the Profile feature from the feature list.
- 3) Select the Report view to display the Report toolbar.
- 4) Press the Export button to display the Export menu.
- 5) Select either:
 - Cloud .CSV to export to Excel
 - Cloud .DXF to export to a CAD program

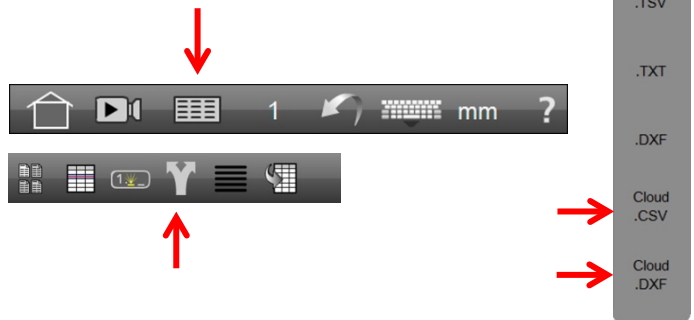

When Cloud .CSV is selected, the spreadsheet file will be created and exported containing each point with a numeric label, X and Y position of the point, the IJ value for the point, the Delta or distance from the point to the part model, the tolerance band and percentage of the tolerance band used by the point.

A1		fx Feature								
	A	B	C	D	E	F	G	H	I	
1	Feature	Pt #	X	Y	I	J	Delta	Tol	T%	
2	Profile 1	1	12.3	-15.576	1	0	0.396	0.3	131.961	
3	Profile 1	2	12.677	-15.835	1	0	0.187	0.3	62.307	
4	Profile 1	3	12.826	-16.065	1	0	0.024	0.301	7.986	
5	Profile 1	4	12.933	-16.341	1	0	0.286	0.301	94.941	
6	Profile 1	5	12.998	-16.63	1	0	0.232	0.301	76.965	
7	Profile 1	6	12.998	-16.91	1	0	0.228	0.301	75.775	
8	Profile 1	7	12.989	-17.183	1	0	0.235	0.301	77.872	
9	Profile 1	8	12.993	-17.455	1	0	0.228	0.301	75.724	
10	Profile 1	9	13	-17.728	1	0	0.217	0.301	72.189	
11	Profile 1	10	13.005	-18.002	1	0	0.21	0.301	69.61	
12	Profile 1	11	13.007	-18.281	1	0	0.205	0.301	68.054	
13	Profile 1	12	12.961	-18.56	1	0	0.248	0.301	82.178	

When Cloud .DXF is selected, a .dxf file containing all of the data points from the profile measurement will be created and exported.

For Authorized and Experienced Personnel Only

The Metlogix.ini file can be modified to enable or disable the display of the DXF overlay in the part view:

[Part View]

DisplayDXFOverlays=1

1=ON // 2=OFF

SOFTWARE LICENSE AGREEMENT

NOTICE TO USER: PLEASE READ THIS AGREEMENT CAREFULLY. BY COPYING, INSTALLING, OR USING ALL OR ANY PORTION OF THE SOFTWARE, YOU ACCEPT ALL TERMS AND CONDITIONS OF THIS AGREEMENT, INCLUDING, IN PARTICULAR THE PROVISIONS ON: TRANSFERABILITY IN SECTION 4; WARRANTY IN SECTIONS 6 AND 7; AND LIABILITY IN SECTION 8. YOU AGREE THAT THIS AGREEMENT IS LIKE ANY WRITTEN NEGOTIATED AGREEMENT SIGNED BY YOU. THIS AGREEMENT IS ENFORCEABLE AGAINST YOU AND ANY LEGAL ENTITY THAT OBTAINED THE SOFTWARE AND ON WHOSE BEHALF IT IS USED; FOR EXAMPLE, IF APPLICABLE, YOUR EMPLOYER. IF YOU DO NOT AGREE TO THE TERMS OF THIS AGREEMENT, DO NOT USE THIS SOFTWARE.

METLOGIX AND ITS SUPPLIERS OWN ALL INTELLECTUAL PROPERTY IN THE SOFTWARE. THE SOFTWARE IS LICENSED, NOT SOLD. METLOGIX PERMITS YOU TO COPY, DOWNLOAD, INSTALL, USE, OR OTHERWISE BENEFIT FROM THE FUNCTIONALITY OR INTELLECTUAL PROPERTY OF THE SOFTWARE ONLY IN ACCORDANCE WITH THE TERMS OF THIS AGREEMENT. USE OF SOME METLOGIX AND SOME NON-METLOGIX MATERIALS AND SERVICES INCLUDED IN OR ACCESSED THROUGH THE SOFTWARE MAY BE SUBJECT TO OTHER TERMS AND CONDITIONS TYPICALLY FOUND IN A SEPARATE LICENSE AGREEMENT, TERM OF USE OR "READ ME" FILE LOCATED WITHIN OR NEAR SUCH MATERIALS AND SERVICES.

THE SOFTWARE MAY INCLUDE TECHNOLOGY DESIGNED TO PREVENT UNAUTHORIZED USE AND COPYING. THIS TECHNOLOGY MAY CAUSE YOUR COMPUTER TO CONNECT TO THE INTERNET WITHOUT NOTICE ON INSTALL, LAUNCH, AND ON AN INTERMITTENT OR REGULAR BASIS THEREAFTER. ONCE CONNECTED, THE SOFTWARE WILL TRANSMIT INFORMATION TO METLOGIX VIA AN INTERNET CONNECTION. METLOGIX MAY USE THE TRANSMITTED INFORMATION, AS WELL AS OTHER INFORMATION YOU OR OUR THIRD PARTIES MAY PROVIDE TO US, TO DETECT OR PREVENT USE OF METLOGIX SOFTWARE THIS IS FRAUDULENT, NOT VALIDLY LICENSED, OR NOT USED IN ACCORDANCE WITH A VALID LICENSE. SOFTWARE THAT FAILS TO CONNECT TO METLOGIX AND SOFTWARE THAT CONNECTS TO METLOGIX WHOSE USE IS FOUND TO NOT TO BE PERMITTED MAY OFFER ONLY LIMITED FUNCTIONALITY OR MAY NOT OPERATE AT ALL.

1. Definitions

"MetLogix" means MetLogix, Incorporated, a Delaware corporation, 175 Canal Street, Manchester, New Hampshire 03101.

"MetLogix Runtime(s)" means MetLogix M3, MetLogix M2, MetLogix M1, MetLogix L3, MetLogix L2, MetLogix L1, MetLogix Test Builder, or MetLogix CFR21.

"Computer" means a virtual or physical computer device that accepts information in digital or similar form and manipulates it for a specific result based on a sequence of instructions.

"Internal Network" means a private, proprietary network resource accessible only by employees and individual contractors (i.e., temporary employees) or a specific corporation or similar business entity. Internal Network does not include portions of the Internet or any other network community open to the public, such as membership or subscription driven groups, associations, and similar organizations.

"Output File" means an output file you created with the Software.

"Permitted Number" means one (1) unless otherwise indicated under a valid license (e.g., volume license) granted by MetLogix.

Digital Comparator and Profile Fit Software User's Guide

"Software" means (a) all of the information with which this agreement is provided, including but not limited to: (i) all software files and other computer information.

2. Software License

If you obtained the Software and any required serial number(s) from MetLogix or one of its authorized licensees (resellers) and as long as you comply with the terms of this Agreement, MetLogix grants you a non-exclusive license to install and use the Software in a manner consistent with its design and Documentation and as further set forth below.

2.1 *Limited Use*

2.1.1

The Software, or portions of the Software, may allow installation and use without a serial number. If so, you may install but not use such non-serialized Software on any number of Computers as part of an organizational deployment plan. Further, you may install and use such non-serialized Software on any number of Computers for demonstration, evaluation, and training purposes only and only if any Output Files or other material produced through such use are used only for internal, non-commercial, and non-production purposes. You may not use such non-serialized Software after any applicable timeout period has ended, unless you input a valid serial number. ACCESS TO AND USE OF ANY OUTPUT FILES CREATED WITH SUCH NON-SERIALIZED SOFTWARE IS ENTIRELY AT YOUR OWN RISK.

2.1.2

The Software, or portions of the Software, that are provided with a serial number designated for "evaluation purposes" or other similar designation (such as Software or a serial number supplied as "EVAL" under a separate ordering document) and that includes an expiration date ("Evaluation Software") may only be installed and used on Computers for demonstration, evaluation, and training purposes only and only if Output Files or other materials produced through such use are used only for internal, non-commercial, and non-production purposes. The Evaluation Software will automatically time out with or without prior notice. You may not use such Evaluation Software after any applicable time-out period has ended, unless you input a valid serial number. USE OF ANY OUTPUT FILES CREATED WITH SUCH NON-SERIALIZED SOFTWARE IS ENTIRELY AT YOUR OWN RISK.

2.1.3 *General Use*

Except as described otherwise herein, you may install and use one (1) copy of the Software in accordance with the Documentation only on the Permitted Number of your compatible Computers into which you enter a valid serial number.

2.1.4 *Distribution from a Server*

The Software may not be distributed from a Server or an Internal Network.

2.1.5 *Dual Boot Platform*

The Software is licensed for use on a specific operating system platform. You must purchase a separate license for use of the Software on each operating system platform.

2.1.6 *Documentation*

You may make copies of the Documentation for your own internal use in connection with use of the Software in accordance with this Agreement but no more than the amount reasonably necessary. Any permitted copy of the Documentation that you make must contain the same copyright and other proprietary notices that appear on or in the Documentation.

3. Intellectual Property Ownership

The Software and any authorized copies that you make are the intellectual property of and are owned by MetLogix Incorporated. The structure, organization, and source code of the Software are the valuable trade secrets and confidential information of MetLogix Incorporated. The Software is protected by law, including but not limited to the copyright laws of the United States and other countries, and by international treaty provisions. Except as expressly stated herein, this Agreement does not grant you any intellectual property rights in the Software and all rights not expressly granted are reserved by MetLogix Incorporated.

4. Restrictions and Requirements

4.1 Notices

Any permitted copy of the Software that you make must contain the same copyright and other proprietary notices that appear on or in the Software.

4.2 Use Obligations

You agree that you will not use the Software other than as permitted by this Agreement and that you will not use the Software in a manner inconsistent with its design or Documentation.

4.3 No Modifications

You may not modify, port, adapt, or translate the Software.

4.4 No Reverse Engineering

You will not reverse engineer, decompile, disassemble, or otherwise attempt to discover the source code of the Software.

4.5 No Unbundling

The Software may include various applications, utilities, and components, may support multiple platforms and languages, and may be provided to you on multiple media or in multiple copies. Nonetheless, the Software is designed and provided to you as a single product to be used as a single produce on Computers permitted by Section 2. You are not required to install all component parts of the Software, but you may not unbundle the component parts of the Software for use on different Computers. You may not unbundle or repackage Software for distribution, transfer, or resale.

4.6 No Transfer

YOU WILL NOT RENT, LEASE, SELL, SUBLICENSE, ASSIGN OR TRANSFER YOUR RIGHTS IN THE SOFTWARE, OR AUTHORIZE ANY PORTION OF THE SOFTWARE TO BE COPIED ONTO ANOTHER INDIVIDUAL OR LEGAL ENTITY'S COMPUTER EXCEPT AS MAY BE EXPRESSLY PERMITTED HEREIN. You may, however, permanently transfer all your rights to use the Software to another individual or legal entity provided that: (a) you also transfer (i) this agreement, (ii) the serial number(s), the Software affixed to medial provided by MetLogix or its authorized distributor, and all other software or hardware bundled, packaged, or pre-installed with the Software, including all copies, Updates, and Prior Versions (as defined in Section 5); (b) you retain no Updates, Prior Versions, or copies, including backups and copies stored on a Computer; and (c) the receiving party accepts the terms and conditions of this agreement and any other terms and conditions under which you purchased a valid license to the Software. NOTWITHSTANDING THE FOREGOING, YOU MAY NOT TRANSFER EDUCATION, PRE-RELEASE, EVALUATION SOFTWARE, OR NOT FOR RESALE COPIES OF THE SOFTWARE OR SOFTWARE OBTAINS UNDER A METLOGIX VOLUME LICENSE PROGRAM EXCEPT AS MAY BE EXPRESSLY PERMITTED BY METLOGIX WITH THE TERMS OF A VOLUME LICENSE PROGRAM.

4.7 No Service Bureau

You will not use or offer the Software on a service bureau basis.

Digital Comparator and Profile Fit Software User's Guide

4.8 MetLogix M Series Restrictions

You may not use MetLogix M Series software on any non-PC device or with any embedded or device version of any operating system.

5. Updates

If the Software is an Update to a prior version of MetLogix software (the "Prior Version"), the following apply:

Your use of this Update is conditional upon your retention of the Prior Version. Therefore, if you validly transfer this Update pursuant to Section 4.6, you must transfer the Prior Version along with it. If you wish to use this Update in addition to the Prior Version, you may only do so on the same computer on which you have installed and are using the Prior Version. Any obligation that MetLogix may have to support Prior Versions may end upon the availability of this Update. No other use of the Update is permitted. Additional Updates may be licensed to you by MetLogix with additional or different items.

6. Limited Warranty

MetLogix warrants to the individual or entity that first purchases a license for the Software for use pursuant to the terms of this agreement that the Software will perform substantially in accordance with the Documentation for the ninety (90) day period following receipt of the Software when used on the recommended operating system and hardware configuration. Non-substantial variation of performance from the Documentation does not establish a warranty right. This limited warranty does not apply to the following which are made available "AS-IS" and without warranty from MetLogix: patches, font software; pre-release (beta), trial, starter, evaluation, product sampler, and not for resale (NFR) copies of the Software including but not limited to Evaluation Software. All warranty claims must be made, along with proof of purchase, to MetLogix within such ninety (90) day period. If the Software does not perform substantially in accordance with the Documentation, the entire liability of MetLogix and its affiliates and your exclusive remedy will be limited to either, at MetLogix' option, replacement of the Software or refund of the license fee you paid for the Software (if any). THE LIMITED WARRANTY SET FORTH IN THIS SECTION GIVES YOU SPECIFIC LEGAL RIGHTS. YOU MAY HAVE ADDITIONAL RIGHTS UNDER LAW WHICH VARY FROM JURISDICTION TO JURISDICTION. METLOGIX DOES NOT SEEK TO LIMIT YOUR WARRANTY RIGHTS TO ANY EXTENT NOT PERMITTED BY LAW.

7. Disclaimer

THE LIMITED WARRANTY IN SECTION 6 IS THE ONLY WARRANTY OFFERED BY METLOGIX, ITS AFFILIATES, AND SUPPLIERS AND IT STATES THE SOLE AND EXCLUSIVE REMEDIES FOR METLOGIX', ITS AFFILIATES', OR SUPPLIERS' BREACH OF THAT OFFERED WARRANTY. THE LIMITED WARRANTY IN SECTION 6 AND ANY STATUTORY WARRANTY AND REMEDY THAT CANNOT BE EXCLUDED OR LIMITED UNDER LAW ARE THE ONLY WARRANTIES APPLICABLE TO THE SOFTWARE. OTHER THAN THOSE OFFERED AND STATUTORY WARRANTIES APPLICABLE TO THE SOFTWARE, METLOGIX, ITS AFFILIATES, SUPPLIERS, AND CERTIFICATE AUTHORITIES DISCLAIM ALL WARRANTIES, CONDITIONS, REPRESENTATIONS, AND TERMS, EXPRESSED OR IMPLIED, WHETHER BY STATUTE, COMMON LAW, CUSTOM, USAGE, OR OTHERWISE AS TO ANY MATTER, INCLUDING BUT NOT LIMITED TO PERFORMANCE, SECURITY, NON-INFRINGEMENT OF THIRD PARTY RIGHTS, INTEGRATION, MERCHANTABILITY, SATISFACTORY QUALITY, AND FITNESS FOR ANY PARTICULAR PURPOSE. OTHER THAN SUCH OFFERED AND STATUTORY WARRANTIES AND REMEDIES, METLOGIX, ITS AFFILIATES, SUPPLIERS, AND CERTIFICATE AUTHORITIES PROVIDE THE SOFTWARE AND ACCESS TO ANY WEBSITES, METLOGIX OR THIRD PARTY ONLINE SERVICES, AND CERTIFICATE AUTHORITY SERVICES AS-IS AND WITH ALL FAULTS. THIS DISCLAIMER OF WARRANTY MAY NOT BE VALID IN SOME JURISDICTIONS. YOU MAY HAVE ADDITIONAL WARRANTY RIGHTS UNDER LAW WHICH MAY NOT BE WAIVED OR DISCLAIMED. METLOGIX DOES NOT SEEK TO LIMIT YOUR WARRANTY RIGHTS TO ANY EXTENT NOT PERMITTED BY LAW.

8. Limitation of Liability

EXCEPT FOR THE EXCLUSIVE REMEDY OFFERED BY METLOGIX ABOVE AND ANY REMEDIES THAT CANNOT BE EXCLUDED OR LIMITED UNDER LAW, METLOGIX, ITS AFFILIATES, SUPPLIERS AND CERTIFICATE AUTHORITIES WILL NOT BE LIABLE TO YOU FOR ANY LOSS, DAMAGES, CLAIMS, OR COSTS WHATSOEVER INCLUDING ANY CONSEQUENTIAL, INDIRECT OR INCIDENTAL DAMAGES, ANY LOST PROFITS OR LOST SAVINGS, ANY DAMAGES RESULTING FROM BUSINESS INTERRUPTION, PERSONAL INJURY OR FAILURE TO MEET ANY DUTY OF CARE, OR CLAIMS BY THIRD PARTY, EVEN IF ANY METLOGIX REPRESENTATIVE HAS BEEN ADVISED OF THE POSSIBILITY OF SUCH LOSS, DAMAGES, CLAIMS, OR COSTS. IN ANY EVENT, METLOGIX' AGGREGATE LIABILITY AND THAT OF ITS AFFILIATES, SUPPLIERS, AND CERTIFICATE AUTHORITIES UNDER OR IN CONNECTION WITH THIS AGREEMENT WILL BE LIMITED TO THE AMOUNT PAID FOR THE SOFTWARE, IF ANY. THIS LIMITATION WILL APPLY EVENT IN THE EVENT OF A FUNDAMENTAL OR MATERIAL BREACH OR A BREACH OF THE FUNDAMENTAL OR MATERIAL TERMS OF THIS AGREEMENT

THE FOREGOING LIMITATIONS AND EXCLUSIONS APPLY TO THE EXTENT PERMITTED BY APPLICABLE LAW IN YOUR JURISDICTION. THIS LIMITATION OF LIABILITY MAY NOT BE VALID IN SOME JURISDICTIONS. YOU MAY HAVE RIGHTS THAT CANNOT BE WAIVED UNDER CONSUMER PROTECTION AND OTHER LAWS. METLOGIX DOES NOT SEEK TO LIMIT YOUR WARRANTY OR REMEDIES TO ANY EXTENT NOT PERMITTED BY LAW.

9. Export Rules

You acknowledge that the Software is subject to the U.S. Export Administration Regulations and other export laws, restrictions, and regulations (collectively the "Export Laws") and that you will comply with the Export Laws. You will not ship, transfer, export, or re-export the Software, directly or indirectly, to: (a) any countries that are subject to US export restrictions (currently including, but not necessarily limited to, Cuba, Iran, North Korea, Sudan, and Syria) (each, an "Embargoed Country"), (b) any end user who you know or have reason to know will utilize them in design, development or production of nuclear, chemical or biological weapons, or rocket systems, space launch vehicles, and sounding rockets, or unmanned air vehicle systems (each, a "Prohibited Use"), or (c) any end user who has been prohibited from participating in U.S. export transactions by any federal agency of the U.S. government (each, a "Sanctioned Party"). In addition, you are responsible for complying with any local laws in your jurisdiction which may impact your right to import, export or use the Software. You represent and warranty that (i) you are not a citizen of, or located within, an Embargoed Country, (ii) you will not use the Software for a Prohibited Use, and (iii) you are not a Sanctioned Party. All rights to use the Software are granted on condition that such rights are forfeited if you fail to comply with the terms of this agreement.

10. General Provisions

If any part of this Agreement is found void and unenforceable, it will not affect the validity of the balance of this Agreement, which will remain valid and enforceable according to its terms. This Agreement may only be modified in writing, signed by an officer of MetLogix, Inc. The English version of this Agreement will be the version used when interpreting or construing this Agreement. This is the entire Agreement between MetLogix and you relating to the Software and it supersedes any prior representations, discussion, undertakings, communications, or advertising relating to the Software.

11. Notice to U.S. Government End Users

For U.S. Government End Users, MetLogix agrees to comply with all applicable equal opportunity laws including, if appropriate, the provisions of Executive Order 11246, as amended, Section 402 of the Vietnam Era Veterans Readjustment Assistance Act of 1974 (38 USC 4212), and Section 503 of the Rehabilitation Act of 1973, as amended, and the regulations at 41 CFR Parts 60-1 through 60-60, 60-250, and 60-741. The affirmative action clause and regulations contained in the preceding sentence will be incorporated by reference in this Agreement.

12. Compliance with Licenses

If you are a business, company, or organization, you agree that, in addition to any license compliance checking performed by the Software, MetLogix or its authorized representative have the right, no more than once every twelve (12) months, upon ten (10) days' prior notice to you, to inspect your records, systems, and facilities to verify that your use of any and all MetLogix software is in conformity with your valid licenses from MetLogix. For example, MetLogix has the right to those of your records useful to determine whether installations of the Software have, or have not, been serialized, and you shall provide such records to MetLogix promptly upon request by MetLogix. Additionally, you shall provide MetLogix with all records and information requested by MetLogix in order to verify that your use of any and all MetLogix software is in conformity with your valid licenses from MetLogix within thirty (30) days of MetLogix' request.

13. Peer to Peer Communications

The Software may use your connection to a local area network, without additional notice, automatically connect to other MetLogix software and, in doing so, may indicate on the local area network that it is available for communication with other MetLogix software. These connections may transmit the IP Address of your connection to the local network but no personally identifiable information is ever transmitted or received through such network connections (except to the extent that IP addresses may be considered personally identifiable in some jurisdictions).

