



**Galileo<sup>®</sup> Standard Series Video Metrology Systems  
EZ200 / MV200, EZ300 / MV300, AV200, AV300  
User Manual**



**Starrett Kinematic Engineering**

26052 Merit Circle, Suite 103  
Laguna Hills, CA 92653, USA  
[www.starrettkinematic.com](http://www.starrettkinematic.com)  
Phone: (949) 348-1213  
Fax: (949) 582-804

# Table of Contents

<b>1. PREFACE</b> .....	<b>4</b>
1.1 Welcome .....	4
1.2 Safety Symbols & Terminology .....	4
1.3 Warranty.....	4
1.4 Disclaimer of Liabilities.....	5
1.5 Copyright & Trademark Information.....	5
<b>2. PRODUCT INTRODUCTION</b> .....	<b>6</b>
2.1 Components, Galileo Manual QC300 DRO, QC5000 or M3 Systems.....	8
2.1.1 X-Y Stage Manual Controls.....	8
2.1.2 Z-Column Manual Control.....	8
2.1.3 Optical Probe.....	8
2.1.4 Display & Readout Alternatives.....	9
2.2 Components, Galileo CNC QC5000 System.....	10
2.2.1 X-Y Stages.....	10
2.2.2 Z-Column.....	10
2.2.3 Optical Probe.....	11
2.2.4 X-Y-Z Motion Control.....	11
2.2.5 Computer Peripherals .....	11
2.2.6 Integrated Workstation (optional) .....	11
2.2.7 CNC Metrology Software.....	11
2.3 Illumination Sources.....	11
2.4 Environmental Considerations.....	12
2.5 Safety Considerations.....	13
2.6 Specifications .....	14
2.6.1 Physical Dimensions .....	14
2.6.2 System Travel, Accuracy and Resolution.....	15
2.6.3 Quadra-Chek DRO Manual System Connections.....	16
2.6.4 M3 Touchscreen PC Manual System Connections.....	17
2.6.5 QC5000 CNC System Connections .....	19
2.6.6 Stage Tooling Diagrams.....	21
<b>3. INSTALLATION</b> .....	<b>22</b>
3.1 Required Tools .....	22
3.2 Uncrating of Stage Unit and Optional Workstation.....	22
3.3 Placement and Leveling of Workstation.....	22
3.4 Placement of System Components .....	23
3.5 Cable Attachment .....	23
3.6 Power Connection.....	23
3.7 Initial Setup.....	24
<b>4. OPERATION</b> .....	<b>25</b>
4.1 Manual Series Operation .....	25
4.1.1 Power Application.....	25
4.1.2 X-Y-Z Position Control.....	25
4.1.3 Image Focus Control .....	25
4.1.4 Zoom Control.....	25
4.1.5 Light Intensity Control.....	26
4.1.6 Video Camera Adjustment .....	26
4.1.7 Video Image Display .....	27
4.1.8 Z-Axis Slide Adjustment Procedure.....	27
4.1.9 Relocating the Z-axis Slide for Extended Height Measurements.....	27
4.1.10 Resetting the Z-axis to its Original State.....	27
4.1.11 QC320 & QC321 DRO Metrology Interfaces.....	27

4.2	CNC Series Operation .....	28
4.2.1	Power Switches .....	28
4.2.2	CNC Series Homing Sequence .....	28
4.2.3	Joystick & Trackball Controller .....	29
4.2.4	Image Focus Control .....	29
4.2.5	Lighting Control .....	29
4.2.6	Display Monitor Control .....	29
4.3	CNC Series QC5000 Metrology Software .....	29
4.3.1	Magnification Control .....	30
4.3.2	Lighting Control .....	30
4.3.3	Part Image / Video Probes .....	30
4.3.4	Part View .....	30
4.3.5	Measurement Results .....	31
4.3.6	Features List .....	31
4.3.7	Programming .....	31
4.4	General Operating Considerations .....	31
4.4.1	Lighting Considerations .....	31
4.4.2	Magnification Considerations .....	31
4.4.3	Focus Considerations .....	31
4.4.4	Part Fixturing .....	32
<b>5.</b>	<b>SYSTEM MAINTENANCE .....</b>	<b>33</b>
5.1	Daily Inspections .....	33
5.2	Optical Alignment Verification .....	33
5.2.1	Parfocality & Focus .....	33
5.2.2	Parcentricity .....	34
5.2.3	Squareness .....	34
5.3	Calibration Verification .....	34
5.3.1	Calibration Verification Procedure .....	35
5.4	Cleaning .....	36
5.4.1	Cleaning External Surfaces .....	36
5.4.2	Cleaning Optics .....	36
5.4.3	Cleaning Mechanical Parts .....	37
5.5	Lubrication .....	37
5.6	Auxiliary Lens Replacement .....	37
5.7	Bulb Replacement .....	37
5.8	Periodic Calibration and Maintenance Service .....	39
<b>6.</b>	<b>GLOSSARY .....</b>	<b>40</b>





# 1. PREFACE

## 1.1 Welcome

Thank you for purchasing a Galileo® Standard Series Video Metrology System. We are pleased that your search has led you to Starrett Kinematic Engineering, a subsidiary of the L.S. Starrett Company. This manual is intended to maximize your satisfaction with your system and ensure the most in operating performance. Please feel free to contact Starrett Kinematic at any time. We value your feedback and your satisfaction as a customer.

## 1.2 Safety Symbols & Terminology

The following symbols and terms are used in this manual to call attention to important safety issues. Heed these notices carefully in order to avoid personal injury or damage to the system.

Symbol or Term	Meaning
	Accompanies a <b>DANGER, WARNING</b> or <b>CAUTION</b> message. Failure to heed the message may result in personal injury, death, or equipment damage. See terms below for further information.
	<b>WARNING:</b> Risk of Electrical Shock. Failure to observe this warning may result in personal injury, death, or equipment damage.
	<b>WARNING:</b> Disconnect equipment from power source. Failure to observe this warning may result in personal injury, death, or equipment damage.
	<b>CAUTION:</b> Pinch Point - Keep hands clear. Failure to observe this warning may result in minor to severe personal injury or equipment damage.
	Accompanies a <b>NOTE</b> message. Information contained in the NOTE message is useful or helpful in operating the equipment properly.
<b>DANGER</b>	Immediate hazards which <b>WILL</b> result in severe personal injury or death.
<b>WARNING</b>	Hazards or unsafe practices which <b>COULD</b> result in severe personal injury or death.
<b>CAUTION</b>	Hazards or unsafe practices which <b>COULD</b> result in minor injury or equipment damage.
<b>NOTE</b>	Information that is useful or helpful in operating the equipment properly.

## 1.3 Warranty

Starrett Kinematic products carry a one-year (from date of purchase) warranty against defects in material and workmanship (parts and labor), subject to factory inspection. The L.S. Starrett Company will repair or replace, at its option, any part or parts found to be defective in workmanship or material. Starrett warrants repaired or replaced parts for the balance of the original warranty period or 90 days, whichever is longer. Parts returned to the factory under warranty will be repaired at no charge. Freight charges to the factory will be paid by the customer. Return freight charges to the customer will be paid by Starrett.

This warranty does not cover damages from such causes as abuse, accident, neglect, fire or freight damage. It does not apply to defects resulting from modifications made by the customer or improper use of the system or its components.

## **1.4 Disclaimer of Liabilities**

The L.S. Starrett Company shall have no liability or responsibility to the customer or any other person or entity with respect to any liability, loss or damage caused or alleged to be caused directly or indirectly by this documentation, or the hardware described in it. This includes but is not limited to any interruption of service, loss of business or anticipatory profits, or consequential damages resulting from the use or operation of hardware or equipment.

## **1.5 Copyright & Trademark Information**

Windows is a registered Trademarks of Microsoft Corporation. Quadra-Chek, QC300, QC320, QC321 and QC5000 are registered trademarks of Heidenhain Corporation.

## 2. PRODUCT INTRODUCTION

**Starrett Kinematic Galileo® Standard Series Systems** provide a flexible and comprehensive metrology solution for a wide range of industrial applications. From simple, manual single-feature operation to complex, automated parts measurements, these systems combine high-resolution images with a sturdy, precision mechanical platform to deliver superb accuracy.

All models combine powerful metrology software, ease of use, and versatility to provide consistent, reliable operation. They are constructed for highest accuracy before compensation is applied, providing exceptional performance that users can rely on. Accurate motion, repeatable positioning and orthogonality are fundamental to all Galileo Video Metrology Systems. Ring lighting from the top, substage back-lighting from below the stage, and optional through-the-lens coaxial surface lighting allow users to view bright, sharp and clear images to meet the most challenging edge contrast requirements.

Galileo Standard Series Video Metrology Systems come in two stage sizes (4"x8" or 6"x12") and with three types of controllers (Quadra-Chek® QC300 Digital Readout, QC5000 Controller, and M3-VED Controller). As outlined below, systems can be Manual, meaning that stage positioning and zoom control are by means of manual knobs, or Computer Numerical Controlled (CNC), meaning that stage positioning and zoom control are under computer control.

- 1. Manual Galileo systems with a QC300-VED DRO.** In these systems, the stage is moved in the X-Y or X-Y-Z directions by means of manual knobs, and camera zoom control is by a manual adjustment ring. A compact Digital Readout (DRO) unit serves as the operator interface, displays the video image of the part to be measured, digitizes the video to detect edges, performs metrology calculations, and controls illumination. The 8.5" color LCD touchscreen of the DRO displays the camera image, edge tools, and numerical metrology results.
- 2. Manual Galileo systems with an M3-VED Controller and touchscreen PC.** In these systems, stage movement and zoom control are still manual, but operator control is via a state-of-the-art touchscreen computer. Intuitive touchscreen operation is supported by M3-VED software, which includes pan and zoom with pinch, swipe or touch. Edges to be detected and metrology functions can be selected at a touch of the screen. A keyboard and mouse are also provided. An M3 Controller unit interfaces the stage unit to the touchscreen PC.
- 3. Manual Galileo systems with a QC5000® Controller.** In these systems, stage movement and zoom control are still manual, but the DRO has been replaced by the more powerful QC5000 Controller (an industrial PC), plus a 24" video monitor, keyboard and mouse. Higher video resolution and advanced software features, such as DXF file CAD import, make manual QC5000 systems ideal for demanding metrology tasks.
- 4. Computer Numerical Control (CNC) Galileo systems with a QC5000® Controller.** In these systems, the manual knobs for motion in the X-Y or X-Y-Z directions as well as zoom control have been replaced by stepper or servo motors, making these systems ideal for automated, repetitive measurements. Manually controlled measurements can also be performed by using an included joystick and trackball unit. CNC systems are also called AV systems for "Automated Video."

### Model Numbers

Standard Series Galileo stage units have model numbers EZ200, EZ300, MV200, EZ300, MV300, AV200 or AV300. The first two letters EZ (replaced by MV for export) indicate a manual system, while AV indicates an Automated Video system (same as CNC). The last three digits 200 indicate a 4"x8" stage, while 300 indicates a 6"x12" stage.

Manual controllers can be a QC320-VED DRO for X-Y measurements, a QC321-VED DRO for X-Y-Z measurements, a QC5200-VED Controller for X-Y measurements, or a QC5300-VED Controller for X-Y-Z measurements. The VED suffix stands for Video Edge Detection.

CNC controllers can be a QC5200-VED Controller for 2D X-Y measurements or a QC5300-VED Controller for 3D X-Y-Z measurements. CNC controllers include a motion controller board, whose output drives an external Motion Controller unit for the axis drive motors and the zoom adjustment motor.

Feature	Manual QC300 Systems	Manual QC5000 or M3-VED Systems	CNC QC5000 Systems
<b>Metrology Unit</b>	<b>EZ200 = MV200</b> (4" x 8" stage) <b>EZ300 = MV300</b> (6" x 12" stage)		<b>AV200</b> (4" x 8" stage) <b>AV300</b> (6"x12" stage)
<b>Measurement Range</b>	X-Y-Z: 200 x 100x 150 mm (8" x 4" x 6") or 300 x 150 x 125 mm (12" x 6" x 5.5")		
<b>Stage Size</b>	X-Y: 368 x 208 mm (14.5" x 8.2") or 493 x 264 mm (19.4" x 10.4")		
<b>Lighting Sources</b> (alternatives)	<ol style="list-style-type: none"> <li>1. Fiber-optic light delivery from an external 150-Watt quartz halogen to a ring light, substage light, and optional through-the-lens coaxial light.</li> <li>2. LED ring light or Contrast Master quad ring light, LED substage light, and optional through-the-lens coaxial light.</li> </ol>		
<b>Camera Type</b>	1/3" color CCD, NTSC or PAL analog interface	1/3" color CCD, USB 2.0 digital interface	
<b>Camera Optics</b>	6.5:1 zoom lens standard, 12:1 zoom lens optional		
<b>Camera Resolution</b>	640 x 480 pixels	1024 x 768 pixels	
<b>Control Electronics</b>	<b>QC320 DRO</b> (2D X-Y) <b>QC321 DRO</b> (3D X-Y-Z)	<b>M3-VDE Controller</b> (3D X, Y, Z) + touchscreen PC <b>QC5200 Controller</b> board (2D X-Y) in PC. <b>QC5300 Controller</b> (3D X, Y, Z) in PC.	
<b>Operator Display</b>	8.5" color LCD touch-screen of DRO	21.5" touchscreen color LCD computer for M3E * 24" flat-screen color LCD monitor for QC5000 *	
<b>Operator Controls</b>	LCD touchscreen and DRO front panel buttons	Touchscreen PC, keyboard & mouse for M3-VED Keyboard, mouse, joystick & trackball for QC5000	
<b>Screen Resolution</b>	320 x 240 pixels	1920 x 1080 pixels, M3-VDE 21.5" touchscreen PC * 1900 x 1080 pixels, QC5000 24" PC monitor *	
<b>Parts Image Window</b>	320 x 240 pixels	1024 x 768 pixels	
<b>Reading Resolution</b>	0.5 µm	0.5 µm	0.1 µm
<b>Stage Drive Method</b>	Manually rotated leadscrews		Motors driven by Motion Controller unit.
<b>Manual Positioning</b>	Manual knobs		Joystick & trackball
<b>Zoom Control</b>	Knurled ring on optical probe		Via QC5000 software
<b>Lighting Control</b>	Via QC300 software	Via M3-VDE or QC5000 software	Via QC5000 software
<b>Key Software Features</b>	Touchscreen operation Video edge detection Single & multi-point tools Basic reporting RS232 interface to a PC Data export to USB drive	Touchscreen operation (M3-VDE only) Advanced video edge detection tools Advanced image annotation Customizable reporting Import & export CAD files Field of View (FOV) measurements	
<b>Calibration</b>	To NIST traceable artifacts		
<b>Warranty</b>	One year		
<b>Optional Items</b>	Z-axis scale, quad lighting, touch probe, rotary table, integrated workstation.		

\* Computer specifications subject to change.

**Table 1 - 2: Manual / CNC System Feature Comparison**

## 2.1 Components, Galileo Manual QC300 DRO, QC5000 or M3 Systems

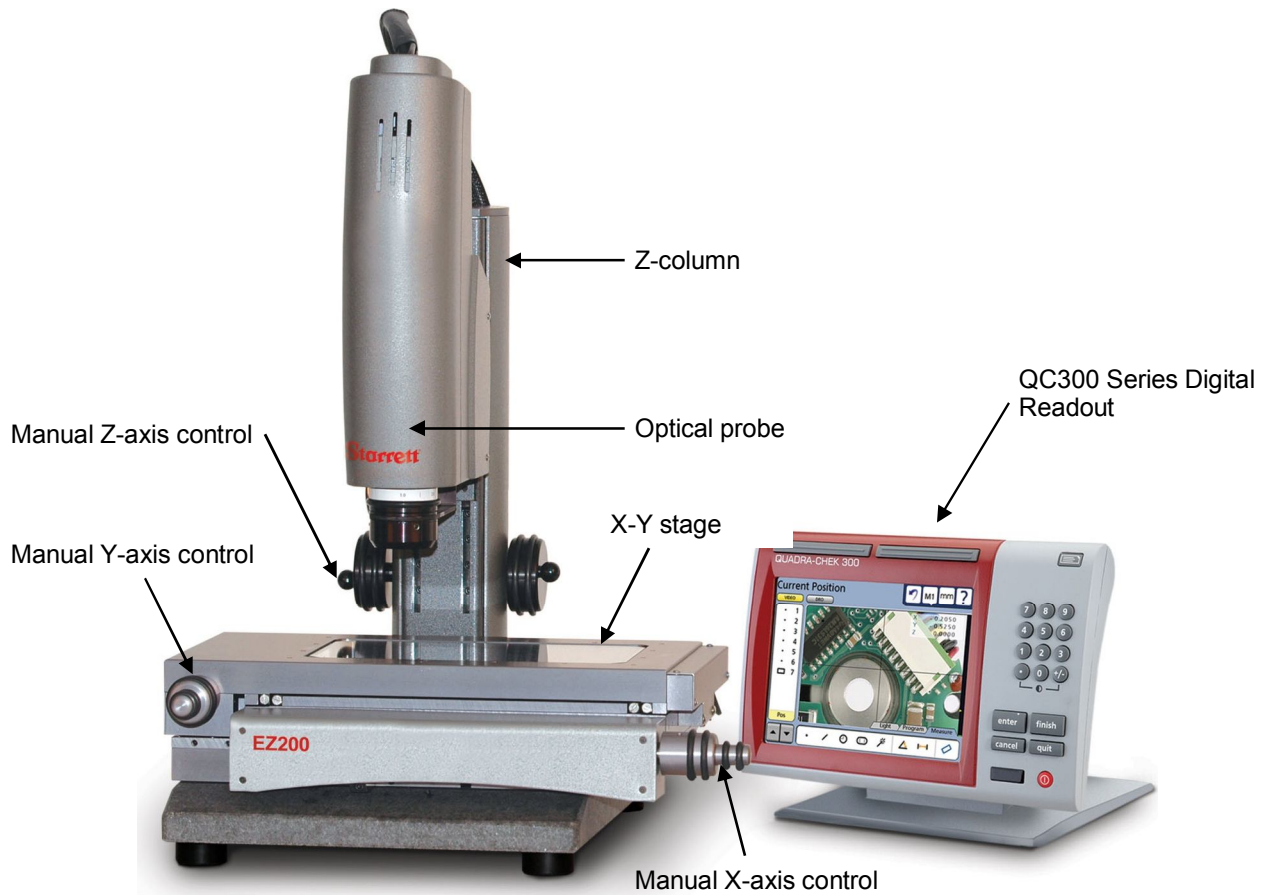

Figure 2 - 1: Galileo Manual System Components

### 2.1.1 X-Y Stage Manual Controls

Two X-Y stage sizes are available for 200 x 100 mm (8" x 4") or 300 x 150 mm (12" x 6") travel. The stages are precision-made from machined aluminum. In Manual systems, X-Y stage motion is by means of manual knobs for coarse and fine control. Surface mounting holes allow customer-designed fixtures for part support. See Figures 2 - 9 and 2 - 10 and for stage tooling surface diagrams.

### 2.1.2 Z-Column Manual Control

A precision cast-aluminum column supports the optical probe. Height adjustment of the optical probe is 150 mm (6") for the 200 x 100 mm (8" x 4") stage and 140 mm (5.5") for the 300 x 150 mm (12" x 6") stage. Z-axis height adjustment is used for optical focus and to accommodate tall parts. A Z-axis positioning knob provides coarse and fine control. Z-axis measurement requires the addition of an optional Z-axis scale and upgrade from the QC320 to the QC321 DRO.

### 2.1.3 Optical Probe

The Optical Probe includes 6.5:1 zoom optics, a CCD color video camera, and a ring light. Options include a through-the lens coaxial light, a high-contrast quad lamp illuminator, and a 2X auxiliary lens. The latter allows parts inspection at greater magnification and precision.



The video camera captures the part image for software analysis and edge detection. The settings of the video camera are preset at the factory and should not be modified. Focus is determined by the distance between the zoom optics and the surface to be analyzed.

In Manual systems, the zoom position and optics height for focus image focus are set manually, with operator feedback via the image on the QC300 DRO, 24" monitor of the QC5000 system, or 21.5" touchscreen of the M3 System.

#### 2.1.4 Display & Readout Alternatives

**A QC300 Series DRO** is an economical and rugged bench-top unit that has been optimized for use with manual metrology stages. Standard features include an 8.5" (diagonal) LCD color touchscreen, color video imaging of the workpiece in a 320 x 240 pixel field, edge detection tools, processing of the measurement data, and numerical readout. Included are parallel, serial and USB ports for use with printers and networks. A 3 kg (7-lb) base assures physical stability. For a brief operational description of the QC300 DRO, please refer to the Operation chapter. For full details, please refer to the separate QC300 DRO manual.

**An M3-VED system** includes a powerful touchscreen PC with a 21.5" color monitor, keyboard and mouse. The monitor screen has 1920 x 1080 pixel resolution and displays the video image of the workpiece in a 1024 x 768 pixel window for large field of view (FOV). It has more capabilities than the DRO, including intuitive touchscreen metrology software that can pan and zoom with pinch, swipe or touch. Edges and metrology functions can be selected at a touch of the screen. For operation, please refer to the separate MetLogix M3 Video Inspection Software User's Guide. The interface between the stage unit and the PC is provided by an M3 Controller unit. This unit communicates with the PC via a USB 2.0 link, accepts the encoder signals from the stages, and outputs lighting control signals via a special cable.

**A manual QC5000 system** includes a powerful PC that comes with a 24" color video monitor, keyboard and mouse. The monitor screen has 1920 x 1080 pixel resolution and displays the video image of the workpiece in a 1024 x 768 pixel window. A wider set of edge detection tools and advanced software make this Starrett Kinematic's most powerful manual metrology system. For operation, please refer to the separate QC5000 Software Manual. The interface between the stage unit and the PC is provided by a special PCI controller board in the PC. This board accepts the encoder signals from the stages and outputs control signals to the lighting controller via a special cable.

## 2.2 Components, Galileo CNC QC5000 System

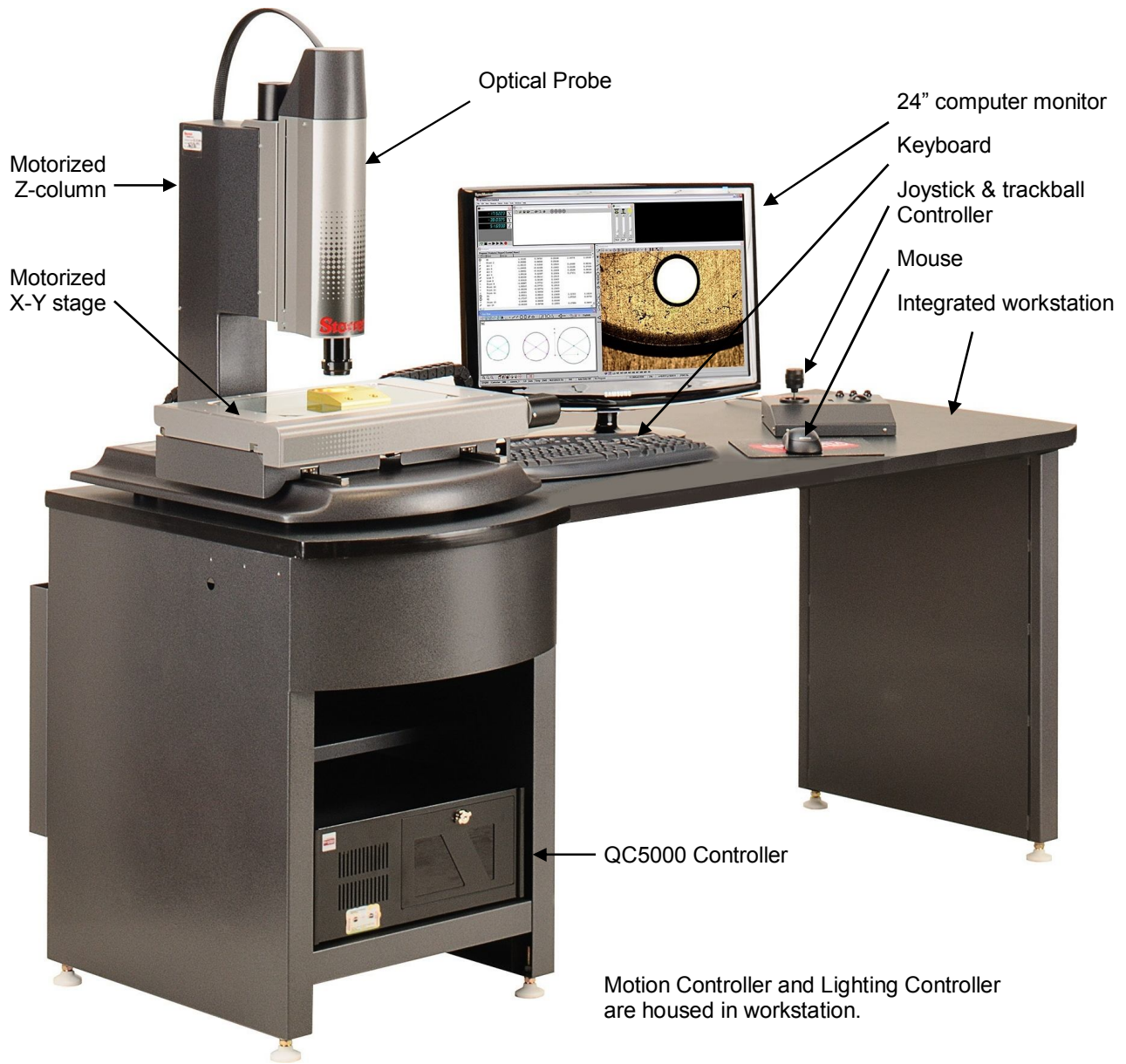

Figure 2 - 2: Galileo CNC QC5000 System Components

### 2.2.1 X-Y Stages

Two X-Y stage sizes are available for 200 x 100 mm (8" x 4") or 300 x 150 mm (12" x 6") travel. The stages are precision-made from machined aluminum. Surface mounting holes allow customer-designed fixtures for part support. Stage motion is by means of stepper or servo motors. See Figures 2 - 9 and 2- 10 for stage tooling surface diagrams.

### 2.2.2 Z-Column

A precision cast-aluminum column supports the optical probe. Height adjustment of the optical probe is 150 mm (6") for a 200 x 100 mm (8" x 4") stage, and 140 mm (5.5") for a 300 x 150 mm (12" x 6") stage. Height adjustment is used for optical focus and to accommodate tall parts. Motion along the Z-axis is by means of a stepper or servo motor.

### 2.2.3 Optical Probe

The Optical Probe includes 6.5:1 zoom optics, a high-resolution CCD video camera, and a ring light. Options includes a through-the lens coaxial light, a high-contrast quad lamp illuminator, and an optional 2X auxiliary lens. The latter allows parts inspection at greater magnification and precision. The video camera captures the part image for software analysis and edge detection. Focus is determined by the distance between the zoom optics and surface to be analyzed. The settings of the video camera are preset at the factory and should not be modified. In CNC systems, the zoom lens position and optics height are computer controlled via QC5000 software.

### 2.2.4 X-Y-Z Motion Control

In CNC systems, X-Y-Z motion is achieved by a stepper motor or a servo motor for each axis. Each motor is driven by an output from a Motion Controller unit, which receives signals from an interface board in the system QC5000 controller PC. Stage movement can be computer controlled via QC5000 software, or be manually controlled via the system's external joystick / trackball control unit. The latter is used during manual inspection and in teaching inspection routines for automated inspection.

### 2.2.5 Computer Peripherals

The QC5000 controller (PC) is interfaced to a high-resolution, external 24" flat-screen color LCD monitor, which is used to program the system's QC5000 software and to display parts video images and data. A keyboard and mouse are used for operator input.

### 2.2.6 Integrated Workstation (optional)

An optional ergonomic workstation provides an ample horizontal work surface which supports the main metrology unit, video monitor, keyboard, and mouse. It also provides cabinet space to house the systems QC5000 Controller, Motion Controller, and Lighting Controller. Its footprint is 154 cm (60.5") x 84 cm (33").

### 2.2.7 CNC Metrology Software

QC5000 Windows-based metrology software controls CNC operation. It features an intuitive user interface, a state-of-the-art graphical user interface (GUI), flexible data import and export, and a choice of analysis tools. The software is designed for automated feature measurements, efficient data management, customizable reports, and data output to a wide variety of applications, printers and databases. For full details, please refer to the separate QC5000 software manual.

## 2.3 Illumination Sources

The same lighting choices apply to Galileo manual and CNC systems. These are quartz halogen lamp lighting, LED lighting, and lighting by a quad lamp illuminator. The intensity of all light sources is controlled via software using the QC300 DRO, M3 Controller, or QC5000 Controller.

**With quartz-halogen lighting**, a separate lighting unit houses a separate 150-watt quartz halogen lamp for each of the system's light sources, which can be a ring light, substage light, and optional coaxial light. The light output of each lamp is carried from the lighting unit to the illumination source by means of a fiber-optic cable.

**With LED lighting**, light is emitted by ultra-bright LEDs mounted directly in the ring light, substage light and optional coaxial light.

**An LED quad lamp illuminator** is available as an add-on option for both quartz-halogen and LED systems. It provides four individually adjustable lamps which deliver collimated (or parallel) light to the work surface. The lamps are mounted on a ring which can be raised or lowered. In the lower ring position, the lamps illuminate the work surface at 30° to the horizontal for unmatched, high-contrast, dark field (or side) illumination. In the upper ring position, the light from the lamps is reflected by the sides of an inverted pyramid and illuminates the work surface at 70° to the

horizontal for bright field (or top) illumination, like a right light. The normal ring light cannot be used simultaneously with the quad lamp illuminator.

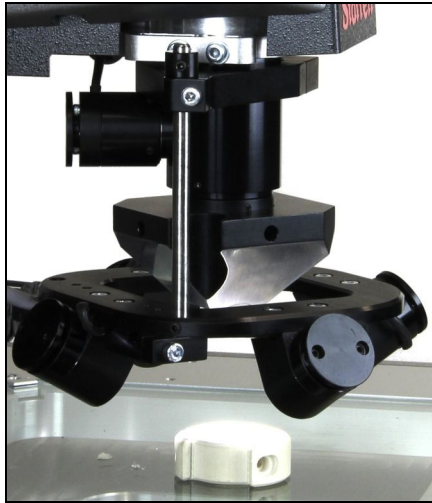

**Figure 2 - 3: Quad lamp Illuminator in its dark field (or side) illumination position.**

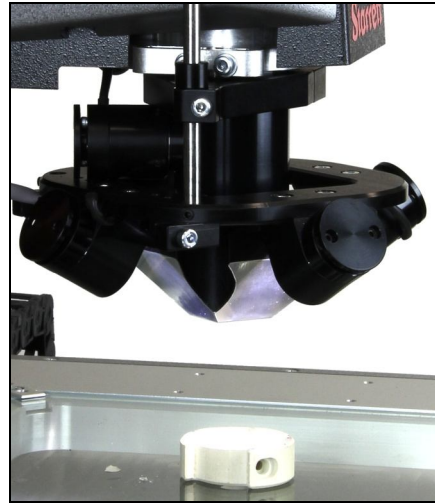

**Figure 2 - 4: Quad lamp Illuminator in its bright field (or top) illumination position.**

## 2.4 Environmental Considerations





Galileo Video Metrology Systems are factory calibrated under the standard laboratory environmental conditions shown below.

Specification	Requirement
Ambient Temperature	20°C ± 0.5°C (68°F ± 1°F)
Humidity	40-60% relative humidity
Temperature rate of change	0.5°C (1°F) per hour

**Table 1 - 3: Environmental Requirements**

If the system is to be operated under environmental conditions that are substantially different from those shown above, the system should be recalibrated under the expected conditions. Also consider material characteristics, such as the coefficient of thermal expansion, of the parts under inspection. Numerical compensation may be required when measuring parts at temperatures substantially different from those stated in the dimensional specifications for these parts.

## 2.5 Safety Considerations

<p><b>General Safety</b></p> 	<p><b>NOTE:</b> Galileo Video Measuring Systems are designed for safety and proper ergonomics during normal use. Exercise caution when lifting, handling or moving the system to avoid personal injury and to maintain equipment calibration and measurement performance. Disconnect all power sources prior to moving or working on the equipment. Consult Starrett if you have any question regarding transporting, using or maintaining these systems.</p> <p>Follow all standard safety protocols for electrical and mechanical equipment in addition to all guidelines outlined in this manual. Failure to exercise proper safety practices may result in damage to the equipment, serious personal injury or death.</p>
<p><b>Electrical Safety</b></p> 	<p><b>WARNING:</b> Follow the guidelines below to protect the equipment, to prevent voiding the warranty, and to avoid hazardous electrical conditions:</p> <ul style="list-style-type: none"> <li>• Power receptacles used with this equipment must be properly grounded 3-prong polarized 120 Vac types for use in North America, or appropriate safety-rated receptacles as used outside of North America.</li> <li>• Keep component air vents clear, clean and free from dust and debris to provide proper circulation to electrical components and to avoid overheating.</li> <li>• Keep all liquids away from the system.</li> <li>• Ensure that the ground is clean, dry and free from debris at all times.</li> <li>• Do not operate the equipment in excessively humid conditions ( &gt; 90% relative humidity).</li> <li>• Do not operate the equipment in an explosive environment, such as around volatile or flammable solvents.</li> <li>• Do not open the metrology cabinet or component housings, except to change light bulbs. All other components are to be serviced by factory-authorized personnel only.</li> <li>• Do not leave covers off the machine components when operating.</li> </ul>
	<p>Disconnect power, or do not apply power, if hazardous conditions exist such as:</p> <ul style="list-style-type: none"> <li>• Damaged or frayed power cord.</li> <li>• Damaged or improperly grounded power receptacle.</li> <li>• Equipment exposed to excessive moisture or liquid spills.</li> <li>• Impact or damage to the equipment. Have the system inspected by authorized personnel before operating.</li> <li>• Ongoing equipment serviced by a technician</li> </ul>
<p><b>Mechanical Safety</b></p> 	<p><b>CAUTION:</b> The CNC metrology stage has automatic moving components. Do not place hands or loose articles of clothing near the moving parts. Failure to observe this warning may result in personal injury and equipment damage.</p>

## 2.6 Specifications

### 2.6.1 Physical Dimensions

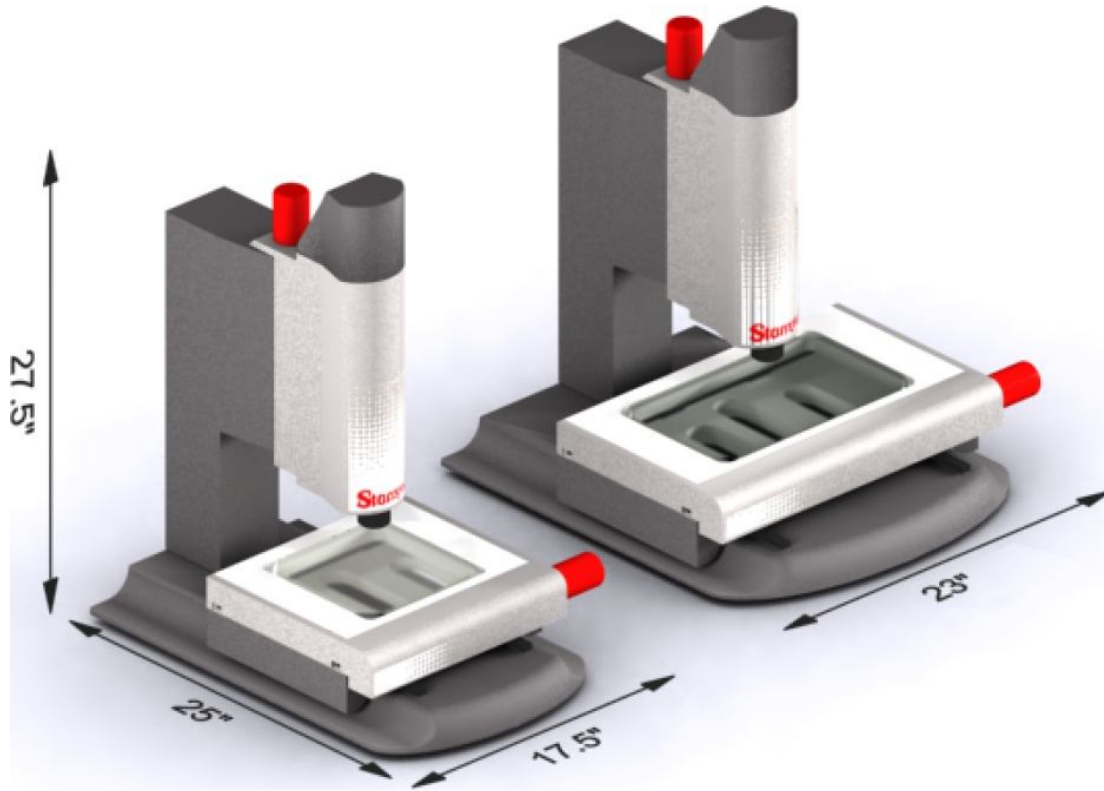

**Figure 2 - 5: Maximum External Dimensions**

Unit	Width	Depth	Height
Metrology Stage, 4x8	45 cm (17.5")	52 cm (20.5")	70 cm (27.5")
Metrology Stage, 6x12	58 cm (23")	63 cm (25")	70 cm (27.5")
Workstation (Bench)	154 cm (60.5")	84 cm (33")	76 cm (30")
Recommended Clearance	30 cm (12")	30 cm (12")	30 cm (12")

**Table 2 - 1: System Dimensions**

Leave sufficient clearance on each side and on the back of the workstation and metrology unit for general safety and for maintenance access. A minimum of 30 cm (12") is recommended on the sides and in the back.

## 2.6.2 System Travel, Accuracy and Resolution

	QC5000 Systems	QC300 & M3-VED Systems
<b>System Travel (X-Y-Z)</b>	200 x 100 x 150 mm (8.0" x 4.0" x 6.0") 300 x 150 x 125 mm (12.0" x 6.0" x 5.5")	
<b>Reading Resolution</b>	0.1 $\mu\text{m}$	0.5 $\mu\text{m}$
<b>Accuracy, X &amp; Y Axes</b>	1.9 $\mu\text{m}$ + 5L/1000	3.5 $\mu\text{m}$ + 5L/1000
<b>Accuracy, Z Axis</b>	2.5 $\mu\text{m}$ + 5L/1000	2.5 $\mu\text{m}$ + 5L/1000

Accuracies are achieved at 68°F  $\pm$  1°F. X-Y accuracies are achieved on a glass surface plate.

**Table 2 - 2: Travel, Resolution and Accuracy Specifications**

	<p><b>CAUTION:</b> Exceeding the maximum load capacity of 40 lbs will reduce accuracies of your system and may damage the mechanical components.</p>
---	--

### 2.6.3 Quadra-Chek DRO Manual System Connections

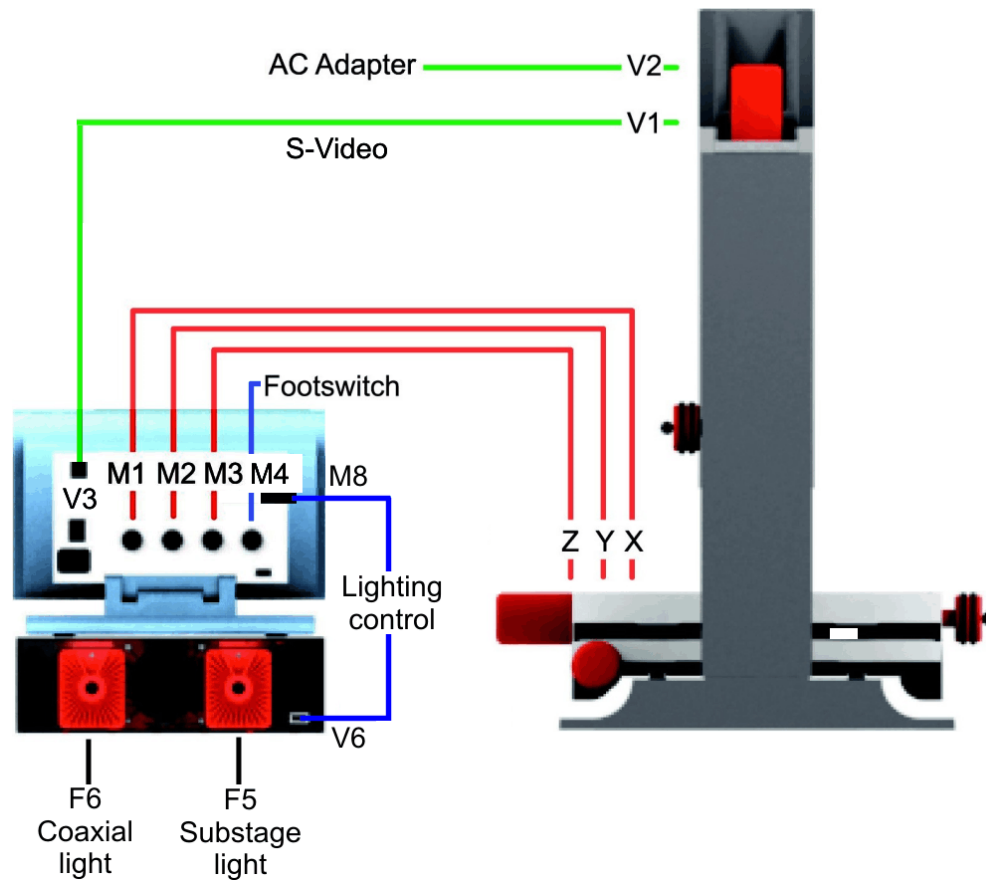

Figure 2 - 6: Quadra-Chek DRO Manual Connections Diagram

END A	DESCRIPTION	END B
M1 @ DRO	X-Axis Encoder Cable	Metrology Unit
M2 @ DRO	Y-Axis Encoder Cable	Metrology Unit
M3 @ DRO	Z-Axis Encoder Cable	Metrology Unit
M4 @ DRO	Footswitch Cable	Footswitch
M8 @ DRO	Lighting Control Cable	V6 @ Illuminator
V3 @ DRO	S-Video Cable	V1 @ Camera
F2 @ Illuminator	Fiber-Optic Cable, Ring Light	Ring Light
F5 @ Illuminator	Fiber-Optic Cable, Substage Light	Substage Light
F6 @ Illuminator	Fiber-Optic Cable, Coaxial Light	Coaxial Light
V2 @ Camera	DC Power Cable	AC Adapter

Cable ends normally have the same label as the label on the port into which they plug.

Table 2 - 3: Quadra-Chek DRO Manual System Connections



## 2.6.4 M3 Touchscreen PC Manual System Connections

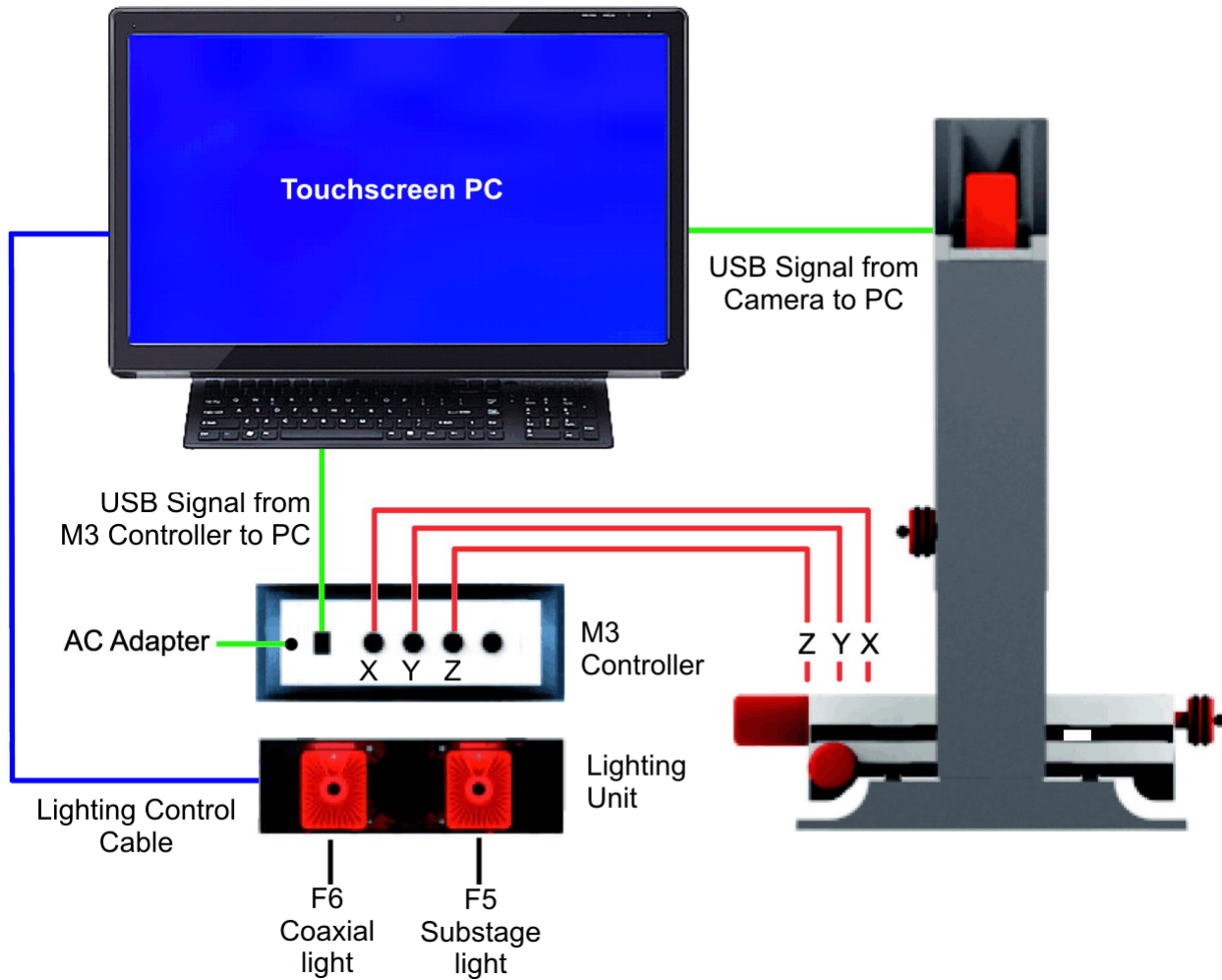

**Figure 2 - 7: Quadra-Chek DRO Manual Connections Diagram**

Cable ends normally have the same label as the port into which they plug.

Cable End A	Cable Description	Cable End B
X @ M3 Controller	X-Axis Encoder Cable	Attached to X Encoder
Y @ M3 Controller	Y-Axis Encoder Cable	Attached to Y Encoder
Z @ M3 Controller	Z-Axis Encoder Cable	Attached to Z Encoder
M7 @ PC	USB Camera Cable	USB @ Camera
M3 @ PC	USB Controller Cable	USB @ M3 Controller
F2 @ Illuminator	Fiber-Optic Cable, Ring Light	Ring Light
F5 @ Illuminator	Fiber-Optic Cable, Substage Light	Substage Light
F6 @ Illuminator	Fiber-Optic Cable, Coaxial Light	Coaxial Light
+12V @ M3 Controller	12V DC Power Cable	AC Adapter

**Table 2 - 4: M3 Touchscreen PC Manual System Connections**

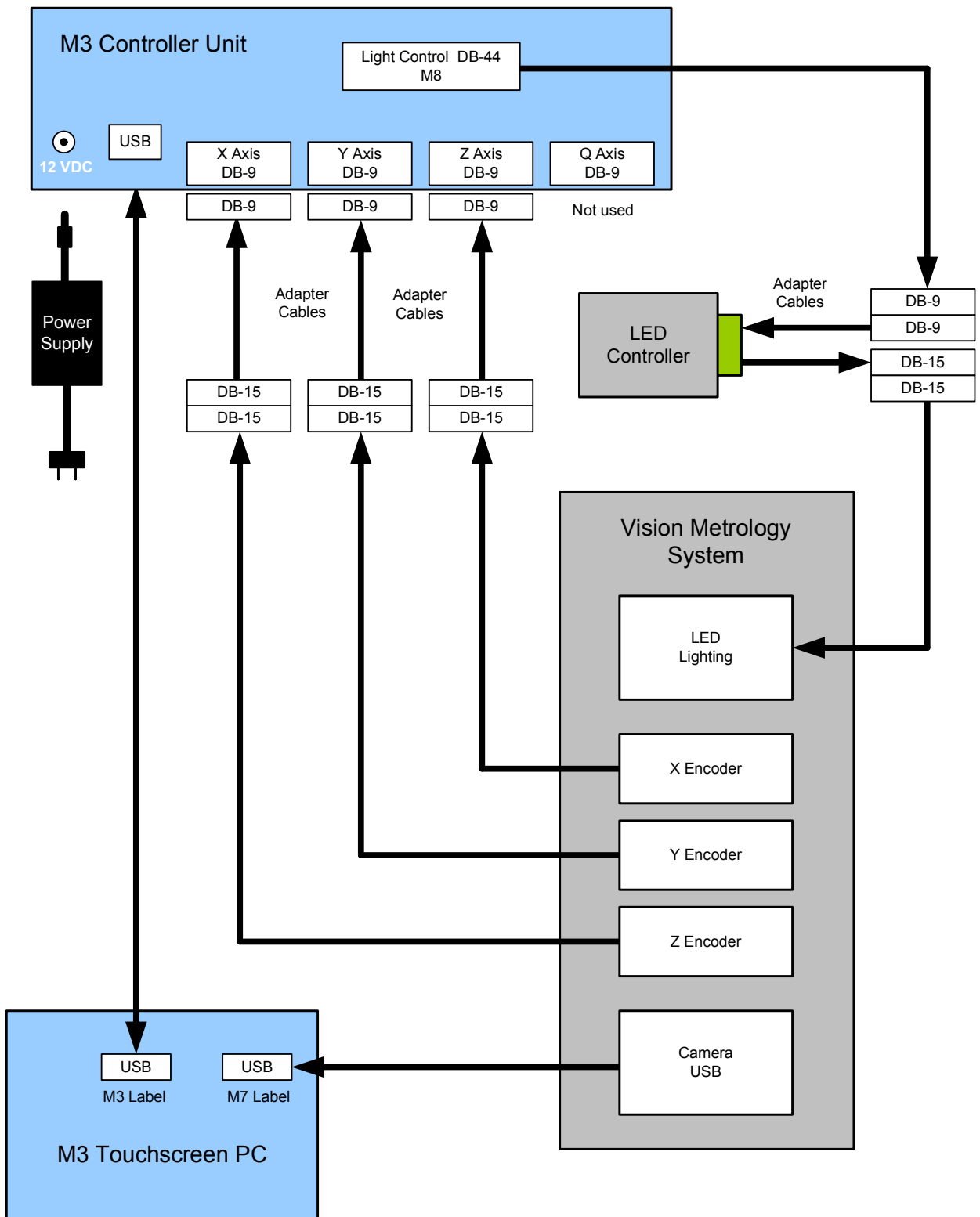

Figure 2 - 8: M3 Touchscreen PC Manual System Connections Detail

## 2.6.5 QC5000 CNC System Connections

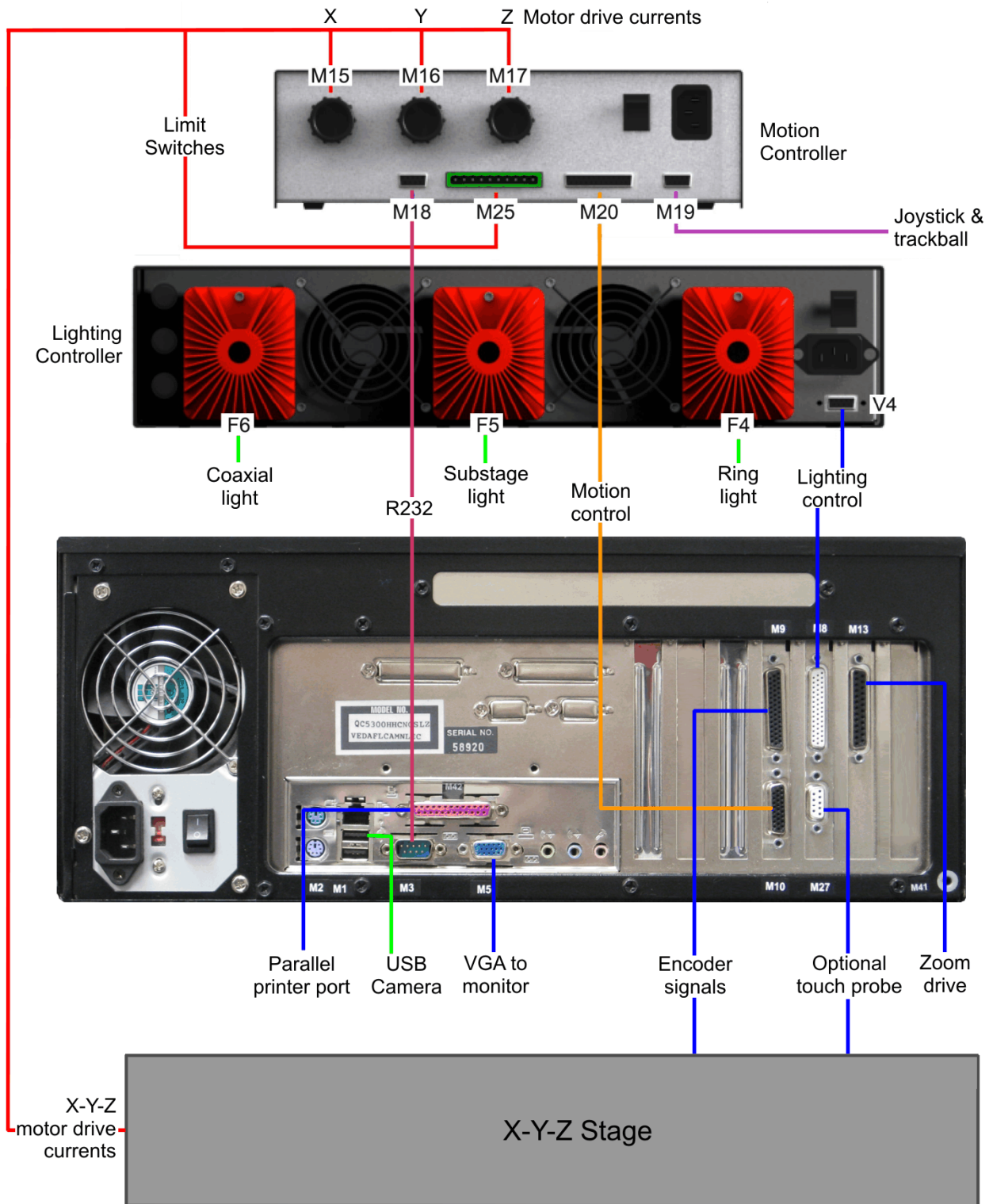



Figure 2 - 9: QC5000 CNC Connections Diagram

The following table outlines the labeling scheme for cables and connections for Galileo CNC Systems. Cables are labeled with the listed alphanumeric marker at each end that must be connected. The listed marker matches the labeled connector in the diagrams below.

	<p><b>TABLE NOTES:</b></p> <ol style="list-style-type: none"> <li>1. Some cables are attached to the metrology stage hardware, and come wrapped together and secured to the stage during shipping.</li> <li>2. Some cables are bundled together in a mesh or shrink-wrapped sleeve. Each separate cable end bears its own label.</li> <li>3. Some cable numbers are not used for the Galileo system, and are unlisted.</li> <li>4. Some connections may already be secured.</li> <li>5. Power connections and power cables are not labeled.</li> </ol>
---	--

Cable End A	Cable Description	Cable End B
<b>M1 @ QC Controller</b>	Mouse Cable	<b>Mouse</b>
<b>M2 @ QC Controller</b>	Keyboard Cable	<b>Keyboard</b>
<b>M3 @ QC Controller</b>	RS232 Cable	<b>M18 @ Motion Controller</b>
<b>M5 @ QC Controller</b>	VGA Cable	<b>Video Monitor</b>
<b>M8 @ QC Controller</b>	Illuminator Signal Cable	<b>V4 @ Illuminator</b>
<b>M9 @ QC Controller</b>	Encoder Cable (splits 1 into 3 cables)	<b>M21 @ X Encoder M22 @ Y Encoder M23 @ Z Encoder</b>
<b>M10 @ QC Controller</b>	Motion Control Cable	<b>M20 @ Motion Controller</b>
<b>M13 @ QC Controller</b>	Zoom output	<b>Zoom Lens</b>
<b>USB @ QC Controller</b>	Camera USB Cable	<b>Video Camera</b>
<b>M15 @ Motion Controller</b>	X-axis Motor Out	<b>X motor</b>
<b>M16 @ Motion Controller</b>	Y-axis Motor Out	<b>Y motor</b>
<b>M17 @ Motion Controller</b>	Z-axis Motor Out	<b>Z motor</b>
<b>M19 @ Motion Controller</b>	Joystick & Trackball Cable	<b>Joystick &amp; Trackball</b>
<b>M25 @ Motion Controller</b>	Limit Switch Cable	<b>Limit Switched on Stage</b>
<b>F4 @ Illuminator</b>	Fiber-Optic Cable, Ring Light	<b>Ring Light</b>
<b>F5 @ Illuminator</b>	Fiber-Optic Cable, Substage Light	<b>Substage Light</b>
<b>F6 @ Illuminator</b>	Fiber-Optic Cable, Coaxial Light	<b>Coaxial Light</b>

**Table 2 - 5: QC5000 CNC System Connections**

## 2.6.6 Stage Tooling Diagrams

The Stage Tooling Plate allows attachment of customer-designed fixtures for part support. Refer to the following diagrams for bolt-hole placement and size.

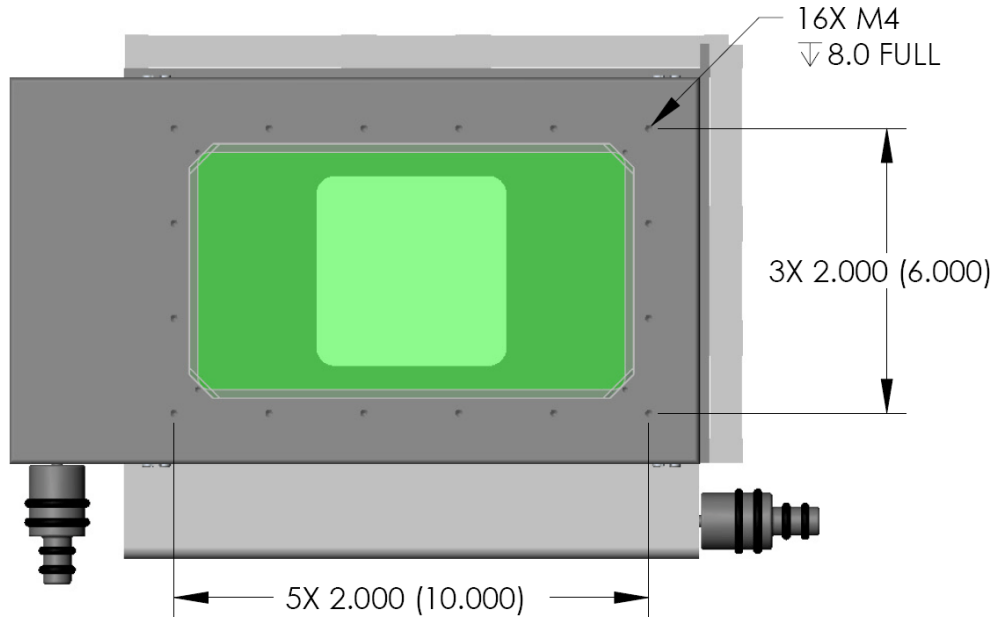

Figure 2 - 10: 4x8 Stage Tooling Plate Diagram

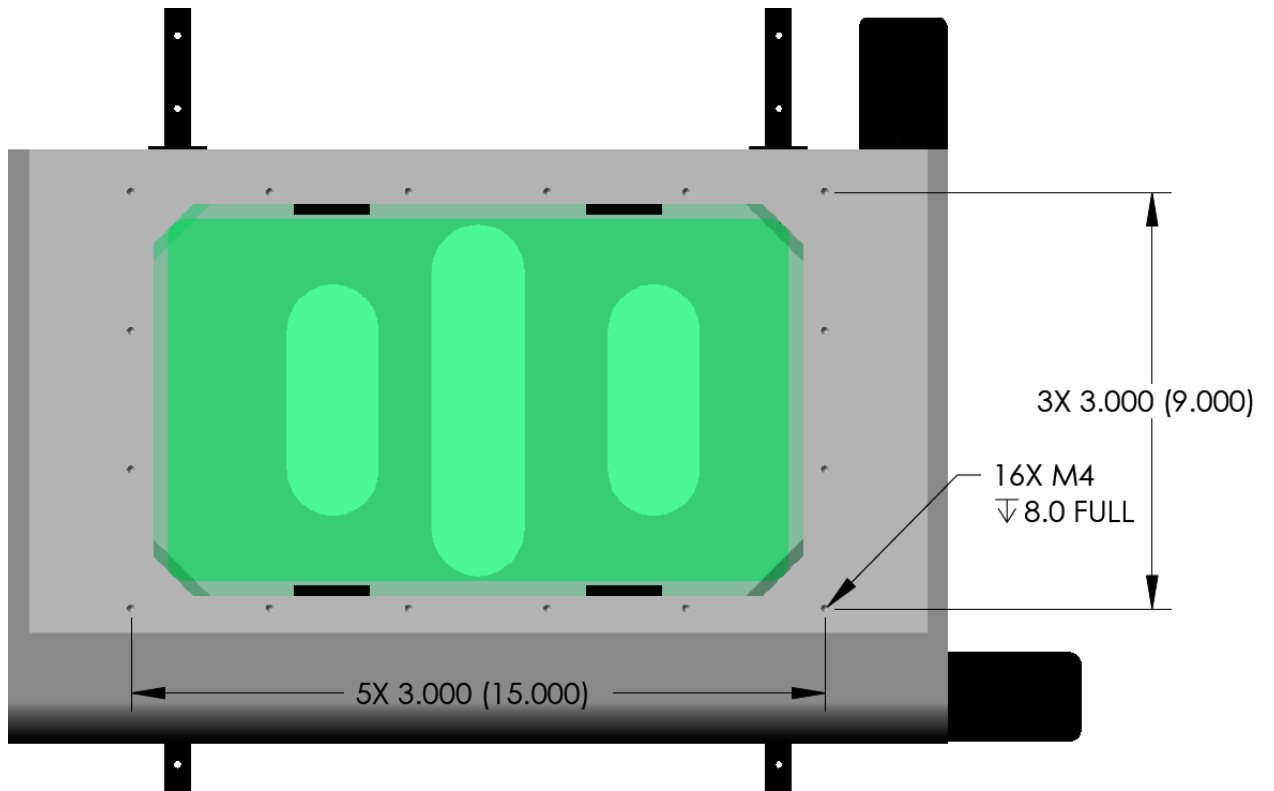
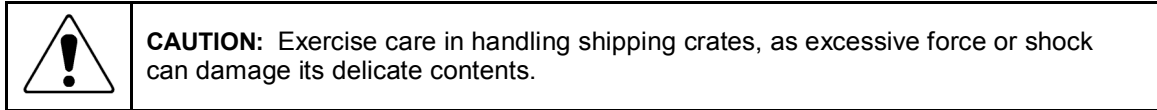

Figure 2 - 11: 6x12 Stage Tooling Plate Diagram

### 3. INSTALLATION

Uncrating and installation are normally performed with the assistance of a trained Starrett Kinematic field service representative or distributor. End users should not do the installations themselves if a trained representative is available.



#### 3.1 Required Tools

The following items are required to uncrate and install the metrology system:

1. Reversing power drill with Phillips bit (to remove screws from crates)
2. Phillips screwdriver
3. Standard slotted screwdriver
4. Small slotted screwdriver for cable connections
5. Industrial level (2 recommended)
6. Metric hex wrenches, 6 mm and smaller
7. Needle nose pliers, 15 cm (6") long
8. Hot-melt glue gun or clay
9. Crescent wrench, 15 cm (6") long, 2 recommended.
10. Black cable ties

#### 3.2 Uncrating of Stage Unit and Optional Workstation

Stage units and optional workstations are shipped in separate custom wooden crates with a pallet base and sides secured with self-tapping drywall screws. Custom crate inserts prevent motion of the contents during shipment.

To open a crate, leave it on the floor. Remove the drywall screws from the sides using a reversing power drill with a Phillips bit, then carefully remove the crate top and sides. Save the custom shipping crate of the stage unit.

Verify that the contents of all shipping containers match the packing checklist included in the documentation packet. Once the presence of all items has been verified, follow the installation and assembly procedures below.

#### 3.3 Placement and Leveling of Workstation

Leave sufficient clearance in the back and on the sides to access the back of the workstation and metrology unit. A minimum clearance of 30 cm (12") is recommended for installation and maintenance.

The optional workstation is supplied with adjustable feet and must be leveled before the metrology unit is placed on top. Use a bubble level to check that the top surface is horizontal. To adjust the feet, use one adjustable crescent wrench to loosen the top hex nut. Use a second wrench against the flattened region of the threaded bolt to rotate the bolt and raise or lower the foot. Tighten the upper nut against the workstation leg to secure the foot. See Figure 3 - 1.

If the workstation is not used, the user-supplied bench or work surface must be leveled before placement of the metrology stage.

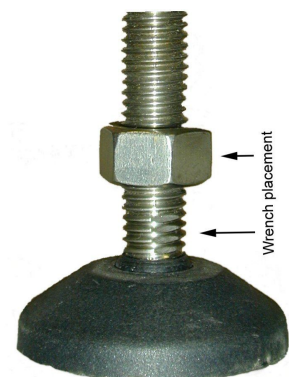

**Figure 3 - 1:**  
**Workstation foot**

### 3.4 Placement of System Components

Once the workstation or user-supplied bench has been leveled, carefully lift the stage unit from its shipping container and place it on the workstation or bench, as shown in Figures 2 -1 and 2 -2.

	<b>CAUTION:</b> Metrology units are heavy. Two men are required to lift even the smallest EV200 / MV200 unit. To lift, bend your knees, not your back.
---	--

Place a Quadra-Chek QC300 DRO, an M3 touchscreen computer, or the video monitor of a QC5000 system on the same work surface as the stage unit. If you are right-handed, these are normally placed to the right of the stage unit.

A QC5000 CNC system has more components, which need to be positioned with care:

1. Position all controllers so that connections facing rearward.
2. Place the Lighting Controller on the top back shelf of the workstation.
3. Place the Motion Controller on the right side of the second back shelf.
4. If the workstation is equipped with only one back shelf, stack the Motion Controller on the Light Controller.
5. Place the PC on the bottom shelf of the workstation.
6. If the workstation is not used, stack the controllers on the customer-provided work surface. Maintain enough clearance from the metrology stage to allow free translation of the X-axis stage during operation.

### 3.5 Cable Attachment

	<b>WARNING:</b> Do not plug in power cables until the entire system has been properly set up per these instructions. Make sure each power plug will be connected to a properly rated and grounded receptacle before applying power to system components.
---	--

The controller cables from the metrology stage are bundled and secured to the stage. Carefully remove the packing materials and ties securing the cables. Attach the controller cables to the corresponding receptacles on the back of the PC. For cable connections, please refer to Figures 2 - 6 and 2 - 7 for Manual Systems and Figure 2 - 8 for CNC Systems.

Reconnect the cable track(s) and mount the lighting units (ring light or optional quad lamp illuminator, and optional coaxial light). Secure the cables using cable ties and the supplied mount on the side of the Z column.

### 3.6 Power Connection

Apply power only after all components have been positioned and all cable connections have been completed. Plug the PC power cable (for CNC system) into the back of the PC, then into the provided power strip. Verify that all power buttons include the switch of the power strip are in the Off position. Plug the power cables into the system or user-supplied power connectors, and then into a properly grounded power socket. Once all cables have been properly attached, power on each component. Turn on the computer of CNC Systems last.

### 3.7 Initial Setup

Before using the system to measure parts, run the system through the following steps to verify proper mechanical and measurement function:

1. **Check that the general operating condition guidelines are observed:**  
See Daily Inspection in the System Maintenance chapter.
2. **Check lighting controls:**  
Manual Series – see Lighting Control in the Operation chapter.  
CNC series – see Lighting Control in the Operation chapter.
3. **Check stage hardware controls – control knobs or joystick:**  
Manual Series – see XYZ Manual Stage Controls and Image Focus Control in the Operation chapter.  
CNC Series – see XYZ CNC Stage Control and Image Focus Control in the Operation chapter.
4. **Check optical zoom:**  
Manual Series – see Magnification Control in the Operation chapter.  
CNC Series – see Magnification Considerations in the Operation chapter.
5. **Check parfocality, parcentricity and squareness:**  
See Optical Alignment Verification in the System Maintenance chapter.
6. **Check calibration:**  
See Calibration Verification in the System Maintenance chapter. In order to validate that the system is in proper working order, take an artifact of known size (such as those on the Galileo MAG checker), and measure the features utilizing the system controls. Once validated, the system may be used on actual parts.



**NOTE:** Factory certification can only be provided upon satisfactory of the calibration / verification procedures by an authorized representative of the L.S. Starrett Co. Use of your system without proper verification and certification is not recommended.



## 4. OPERATION

### 4.1 Manual Series Operation

#### 4.1.1 Power Application

Manual series Metrology Systems are available with a QC300 series DRO or a QC5000 Controller. Each unit has a separate power switch. All devices may be plugged into a switched power strip, and the switch of the power strip can be used to turn on all devices together.

#### 4.1.2 X-Y-Z Position Control

On Manual models, the stages are positioned with individual manual lead-screw knobs, as illustrated.



Figure 4 - 1: Manual metrology system (left), QC300 DRO (right)

#### 4.1.3 Image Focus Control

In Manual and CNC systems, focus is determined by the height of the optical probe, which is set by the manual Z-axis dial. Focus is also partly dependent on magnification. See the General Operation Considerations section at the end of this chapter for tips on best adjustment of image focus and zoom.

#### 4.1.4 Zoom Control

In Manual systems, image zoom (or magnification) is adjusted manually via a zoom adjustment ring, which is accessible on from the front and back of the optical probe. There are six detents for repeatable zoom positioning.



Figure 4 - 2: Manual System Zoom Adjustment

#### 4.1.5 Light Intensity Control

In Manual systems, light intensity can be adjusted in software via the QC300 DRO or QC5000 Controller (if that unit is used instead of the DRO). Adjustable lights are the ring light, substage light, and optional through-the-lens coaxial light. Depending on the system ordered, the light source can be a quartz halogen unit with light output via fiber-optic cables, or LED lamps. Refer to the Bulb Replacement section in the System Maintenance chapter for instructions on replacing quartz-halogen lamps.

#### 4.1.6 Video Camera Adjustment

Manual systems can use a 1/3" CCD color camera with 640 x 480 pixel resolution and an NTSC video interface to a QC300 DRO, or a 1/3" CCD color camera with 1024 x 766 pixel resolution and a USB interface to a QC5000 controller (if that unit is used instead of the DRO). The cameras feature an on-screen menu system for image adjustment. Switches to activate the on-screen menu system are mounted on the camera.

 **NOTE:** Each camera comes preset with factory settings. Do not change settings without consulting with the factory.





Figure 4 - 3: Video Image on QC300 LCD Touchscreen

#### 4.1.7 Video Image Display

The parts image from the video camera can be displayed on the 8.5" color LCD touchscreen of the QC300 DRO or on the 24" color monitor that comes with the QC5000 Controller (if that unit is used instead of the DRO). Overlaid on the video image are edge detection tools and numerical data, as selected in software. In Manual Galileo systems, the part is positioned under the cross-hairs or edge detection tool, and data points are taken. Using the manual stage control knobs, numerical results are then displayed numerically on the screen.

#### 4.1.8 Z-Axis Slide Adjustment Procedure

	<b>NOTE:</b> Extending the Z-axis slide will affect the accuracy of your machine. Care should be taken to assure that the achievable accuracies are within acceptable limits for your application.
	<b>CAUTION:</b> Care should be taken during this process not to allow the Z-axis to slide down and strike anything.

#### 4.1.9 Relocating the Z-axis Slide for Extended Height Measurements

1. Home the machine.
2. Zoom to the highest magnification.
3. Focus on a fixed point on the machine. (The Galileo MAG checker is a good part to use.)
4. Record the X, Y, and Z axis readings.
5. Loosen the three screws on the right side of the optional Z-axis slide.
6. Move to the new location that is required for your Z measurement application.
7. Tighten the three screws loosened previously.
8. You are now ready to use the extended Z-axis.

#### 4.1.10 Resetting the Z-axis to its Original State

1. Home the machine.
2. Zoom to the highest magnification.
3. Move the machine to the X, Y and Z axis readings that were recorded in the earlier process.
4. Loosen the three screws on the right side of the optional Z-axis slide.
5. While viewing the video image, move the Z-axis slide back down until the image is back in focus.
6. Tighten the three screws.

#### 4.1.11 QC320 & QC321 DRO Metrology Interfaces

Model QC320 is the basic Digital Readout for 2D X-Y measurements. Model QC321 adds Z-axis measurement capabilities. It is available in an option package that includes the required Z-axis scale interface hardware. Front panel keys are used to perform standard inspection tasks. Feature Selection keys select the measurement type. Soft keys execute measurement-specific functions. Numerical data can be entered via the keypad. Axes can be zeroed, and datums can be set up using simple button sequences. Keys can be also be programmed to perform common tasks. Please refer to the Quadra-Chek QC300 User's Guide for details.



Figure 4 - 4: QC300 Main Controls

## 4.2 CNC Series Operation

### 4.2.1 Power Switches

The CNC series systems are configured with a PC (computer). The PC should be properly shut down before the remaining system hardware is turned off.

#### Steps to properly power on the CNC system:

1. Power on all other system hardware before turning on the computer.
2. Power on the computer and follow standard logon procedures.

#### Steps to properly power down the CNC system:

1. Save your work as needed in QC5000 software.
2. Close QC5000 software and all other Windows® applications.
3. Using the mouse, click the Start button and on “Turn Off Computer.”
4. After the PC has shut down, turn off the remaining hardware items.

### 4.2.2 CNC Series Homing Sequence

When the QC5000 metrology software is launched, the metrology stage performs an automatic homing sequence. This process establishes the “home” or “zero” position of the X, Y, and Z axes.



**CAUTION:** During the homing sequence, follow proper safety protocols, keeping hands and other objects clear of the moving stage components. Failure to do so could result in personal injury or equipment damage.

### 4.2.3 Joystick & Trackball Controller

Deflecting the joystick from right to left controls movement in the X direction. Deflecting the joystick from front to back controls movement in the Y direction. Rotating the joystick knob controls movement in the Z direction and hence focus. Deflecting the joystick further ramps up speed in the selected direction.

The trackball provides fine control in the X-Y directions or in the Z direction.

The first of three buttons changes maximum joystick speed from slow to fast. The second of three buttons locks the unused axis so that joystick action can be in only X or Y, with no crosstalk from the other axis. The third of three buttons toggles trackball action between the X-Y and Z directions.



**Figure 4 - 5: Joystick & Trackball Stage Control Unit**

### 4.2.4 Image Focus Control

The Z-axis stage control adjusts the image focus. Focus is also partly dependent on magnification. See the General Operation Considerations section below for tips on best adjustment of focus and magnification. The Z axis is controlled by the joystick's center knob; see Figure 3 - 6.

### 4.2.5 Lighting Control

In CNC systems, light intensity is adjusted in software via the QC5000 Controller. Adjustable lights are the ring light, substage light, and optional through-the-lens coaxial light. Depending on the system ordered, the light source can be a quartz halogen unit with light output via fiber-optic cables, or LED lamps. Refer to the Bulb Replacement section in the System Maintenance chapter for instructions on replacing quartz-halogen lamps. In systems equipped with the optional workstation, the lighting controller is mounted beneath the metrology stage (see Figure 1 - 1).

### 4.2.6 Display Monitor Control

CNC systems are supplied with a 24" diagonal flat-screen color LCD monitor with 1900 x 1200 pixel resolution. The real-time video image of the part is displayed in a 1024 x 768 pixel window. Adjusting the monitor has no effect on the measuring ability of the software. For example, adjusting the monitor to make it brighter does not affect edge detection (but changing lighting does).

## 4.3 CNC Series QC5000 Metrology Software

Heidenhain QC5000 metrology software is factory configured for your Galileo system. The software is based on Microsoft Windows™ and is straightforward to learn and easy to operate. All required controls are easily accessed, and data is displayed simply and clearly for quick measurement results. The software interface is organized into the following on-screen sections:

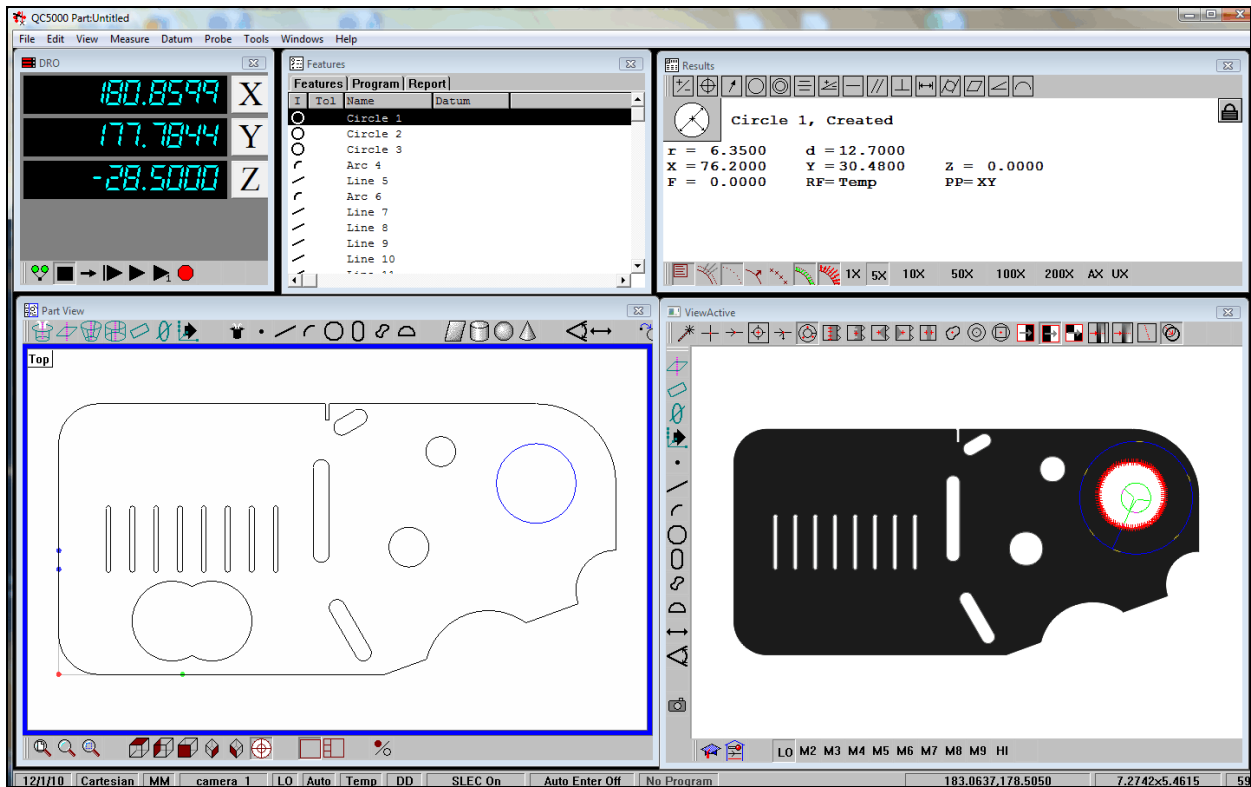

Figure 4 - 6: QC5000 Screen Display

#### 4.3.1 Magnification Control

Video magnification is controlled via preset levels. These are configured during system calibration to precisely control Field-of-View measurements at each magnification. Ten preset magnification levels are available via buttons labeled M1 - M10 at the top of the Video window. The currently selected level is also reported in the status bar. Current pixel size in X and Y is reported at the bottom of the Video window. Pixel size corresponds with the current magnification level. The higher the magnification, the smaller the area represented by each pixel.

#### 4.3.2 Lighting Control

Lighting is programmable and controlled via the Lights window, where sliders and arrow buttons control the level of each light. The current value is reported under each slider. This value is display-only and is not directly editable. The sliders are displayed from left to right for the substage light (transmitted through the stage), on-axis coaxial light (transmitted through the optics), and ring light (illumination from the top).

#### 4.3.3 Part Image / Video Probes

The current video probe (the "tool" used to measure a particular feature) is displayed as an overlay on the part image in the Video window. Probes may be selected from the buttons arranged at the bottom of the Video window. A probe may be positioned on the video image by dragging the tool; the mouse cursor changes to an open hand icon when placed on any free area of the video image. To resize the probe, position the mouse cursor over the probe's lines; the cursor changes to a closed hand or fist. The relevant portion of the tool may be resized by clicking and dragging the closed hand cursor.

#### 4.3.4 Part View

As features are measured, a graphic representation of the features is displayed in the Part View window. A separate View toolbar allows the Part View to be shown from different angles (front, top, left, and so on).

### 4.3.5 Measurement Results

Measurement results are displayed in the Results window. Each feature's results may be displayed separately by selecting the feature in the Part View window. The corresponding result will display in the Results window.

### 4.3.6 Features List

As features are measured, they are listed in the Features List.

### 4.3.7 Programming

Features may be measured as walk-up measurements, or programmed for automated measurement using the Program functions of the software. Please refer to the QC5000 software manual for details.

## 4.4 General Operating Considerations

### 4.4.1 Lighting Considerations

Once the image has been properly focused and magnification has been set, adjust light levels as necessary.

Correct lighting is paramount to accurate measurement with any video-based measurement system. A clear image with lighting toward the low side is recommended. Lighting that is too low will result in a dark, low-contrast image with indiscernible features. Lighting that is too bright may result in a washed-out image that distorts features.

When adjusting lighting, start with light that is lower than desired, then increase lighting while viewing the image on the monitor. Maintain constant lighting for consistent results. In particular, use the same light level while sampling points for a single feature. Do not to change the light level between points used to measure a circle.

Depending on the part characteristics and the feature being measured, the right combination of lighting from the available sources may aid in bringing out a particular feature. Take time to experiment by balancing these light sources.



**NOTE:** In order to preserve lamp life and to reduce unnecessary heat in the system, keep the lights turned down when the system is not in use.

### 4.4.2 Magnification Considerations

Magnification (or zoom) is also important for proper measurements. In general, higher magnification provides greater resolution and accuracy; however, not all features should be inspected at the highest available magnification. Too high a magnification may make it difficult to discern the edge of a feature by exaggerating edge defects such as burrs or chips. Try decreasing the magnification until the edge is more clearly identifiable.

Consider factors such as tolerance requirements, manufacturing processes, functional requirements and optical characteristics of the part. Features with loose tolerances may not need to be inspected at high magnification. Select the highest magnification that is suitable for the feature being inspected.

### 4.4.3 Focus Considerations

Accurate measurement requires proper focus of the image. The part image is at best focus when the magnification is highest. It is often preferable to first focus the image at highest magnification, then decrease the magnification to the desired level.

#### **4.4.4 Part Fixturing**

The part must be fixtured securely to prevent part movement during measurement. Also, proper alignment of the part to the stage can aid in measurement. If the part is off-axis from the stage, X-Y-Z measurements will not correlate as well with the part dimensions. Aligning the part's X or Y axis to the stage will improve dimensional measurements.

This orientation error can also be removed by creating a reference frame based on the part before creating measurements. See the QC5000 software manual for details.



## 5. SYSTEM MAINTENANCE

Your Galileo Manual / CNC Video Metrology System is designed for years of superior service. Periodic maintenance outlined in this chapter should be performed regularly to maintain the system in peak operating condition.

- Daily inspection should be performed to ensure that proper safety guidelines are followed and that the system is operating correctly.
- Basic optical parameters should be verified periodically.
- Cleaning and lubrication should be ongoing for proper mechanical and optical operation.
- Lenses, bulbs and fuses should be maintained and replaced as needed.
- Regular factory-authorized calibration and maintenance service should be scheduled to preserve proper function and accuracy.

### 5.1 Daily Inspections

On a daily basis, the system should be inspected for general safety issues and basic functionality:

- Inspect the area around the system for proper clearance.
- Remove any debris or loose items from around the system and the metrology stage.
- Verify that the work area is clean, dry and free of debris.
- Verify that the electrical power cord is plugged into a grounded power source and is unobstructed.
- Verify that the environmental conditions (temperature and humidity) are within recommended ranges.
- Allow the system to warm up to normal operating temperature before performing critical part measurements.
- Verify that the stage control mechanisms move freely. On CNC Systems, verify through the software that the zoom mechanism also operates freely.

### 5.2 Optical Alignment Verification

The system's optical alignment should be verified regularly to ensure accurate measurement. Parfocality, Parcentricity and Squareness verification is straightforward and may be performed as often as desired.

	<p><b>NOTE:</b> Optical alignment verification may be performed by any qualified operator. However, optical alignment correction should only be performed by an authorized technician. Report any observed alignment discrepancies and contact the factory or your local representative to schedule authorized service.</p>
---	---

#### 5.2.1 Parfocality & Focus

Parfocality is the condition in which the video image will remain in focus as the magnification is adjusted from highest to lowest. The Galileo system is designed to maintain parfocality throughout the available magnification range.

Focus, as described in the Operation chapter, is adjusted by means of adjusting the Z-axis position of the optical system. Therefore, in order to properly inspect parfocality, always reference a flat, sharp edge. Do not select a rough or sloping feature. The Galileo MAG checker provided with the system is an ideal part to use in parfocality inspection.

##### Steps to check parfocality:

1. Place the MAG checker or other suitable inspection part on the stage and secure properly.
2. Backlight the image as necessary. Set light levels as needed to avoid blooming.

3. At low magnification, select a flat, sharp edge in the center of the field of view (FOV).
4. Select highest magnification, and carefully refocus the image by physically moving the Z-axis up or down.
5. While observing the feature, slowly adjust the magnification lower. Verify that the feature remains focused as the magnification is lowered.
6. Report any observed discrepancy. If the error is verified, contact your Starrett representative for authorized service.

### 5.2.2 Parcentricity

Parcentricity describes the condition wherein a feature will remain at the optical center of the video image throughout the magnification range. Like parfocality, parcentricity requires that the feature be first located at highest magnification.

#### Steps to check parcentricity:

1. Place the MAG checker or other suitable inspection part on the stage and secure properly.
2. Select the crosshair image tool and verify that it is at its defined center position. Refer to the QC300 or QC5000 manual for details on centering the crosshair. The crosshair is to remain at this position during the parcentricity test.
3. Zoom to low magnification, and adjust the stage position so that the crosshair is centered on the X-Y axis of the calibration standard (or another suitable feature if the standard is not used).
4. Change to high magnification and refocus the image.
5. Adjust the stage position as needed to recenter the crosshair on the feature.
6. While observing the feature, slowly adjust the magnification lower. Verify that the feature remains at the center of the crosshair as the magnification is lowered.
7. Report any observed discrepancy. If the error is verified, contact your Starrett representative for authorized service.

### 5.2.3 Squareness

Squareness refers to the alignment of the camera relative to the motion of the metrology stage. If the camera is misaligned (out of square), an image will appear to drift diagonally across the video image as the stage position is moved along one axis.

#### Steps to check squareness:

1. Place the MAG checker or other suitable inspection part on the stage and secure properly.
2. Select the crosshair image tool and verify that it is at its defined center position. Refer to the QC300 or QC5000 manual for details.
3. At low mag, select a point-like feature such as a corner or the standard's X-Y origin. Using the stage, position it to the center of the crosshair.
4. Zoom to high magnification, then refocus and recenter the point as needed.
5. While observing the feature, slowly move the stage X axis ONLY. (Do not move the stage Y axis.) Verify that the point remains aligned on the X axis of the crosshair as the feature is moved to the left and right within the field of view
6. Report any observed discrepancy. If the error is verified, contact your Starrett representative for authorized service.

## 5.3 Calibration Verification

Calibration should be verified periodically depending on user requirements and systems usage, and should be at least monthly. A calibration verification standard artifact is available from Starrett authorized distributors or directly from the Starrett service department. Calibration should

also be verified after the system has been serviced or moved. The following is a brief description of the steps recommended for the verification of your machine. Complete calibration and verification procedures are available upon request.

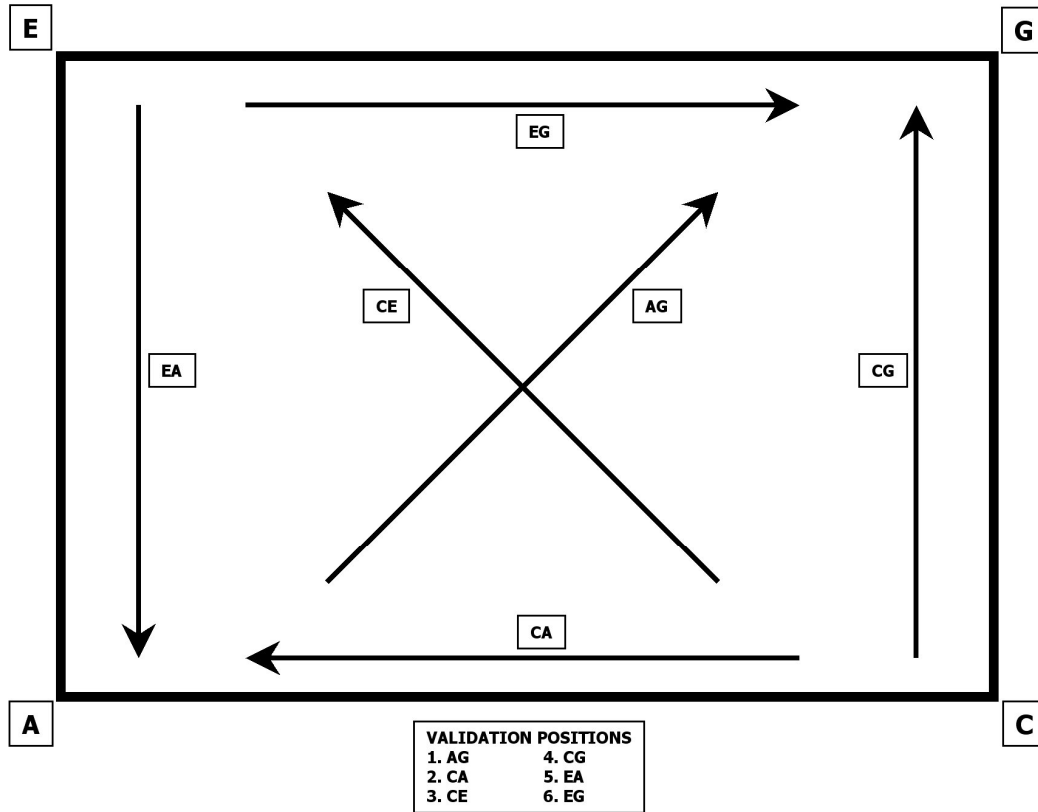

Figure 5 - 1: Verification Standard Placement

### 5.3.1 Calibration Verification Procedure

**Steps to validate calibration:**

1. Place the calibrated verification standard in one the six positions as shown in Figure 4 - 1 on the glass stage. Secure the standard with hot melt glue or other suitable retaining method so that stage translation can not move the standard under any condition.
2. Skew the center of the two end circles. Refer to the QC300 or QC5000 manual for proper alignment procedures.
3. Measure the distance between the 1st and 2nd, 1st and 3rd, 1st and 4th, 1st and 5th, and the 1st and 6th fiducials. Repeat these measurements 10 times.
4. Calculate the absolute average deviation for each of the 5 groups of distance measurements.
5. Repeat the measurements for all six locations shown in the illustration.
6. The absolute averages should be within the factory specification, de-rated for the environment and calibration accuracy. See Table 1 - 5, "Travel, Accuracy and Resolution Specifications" for accuracy specifications.

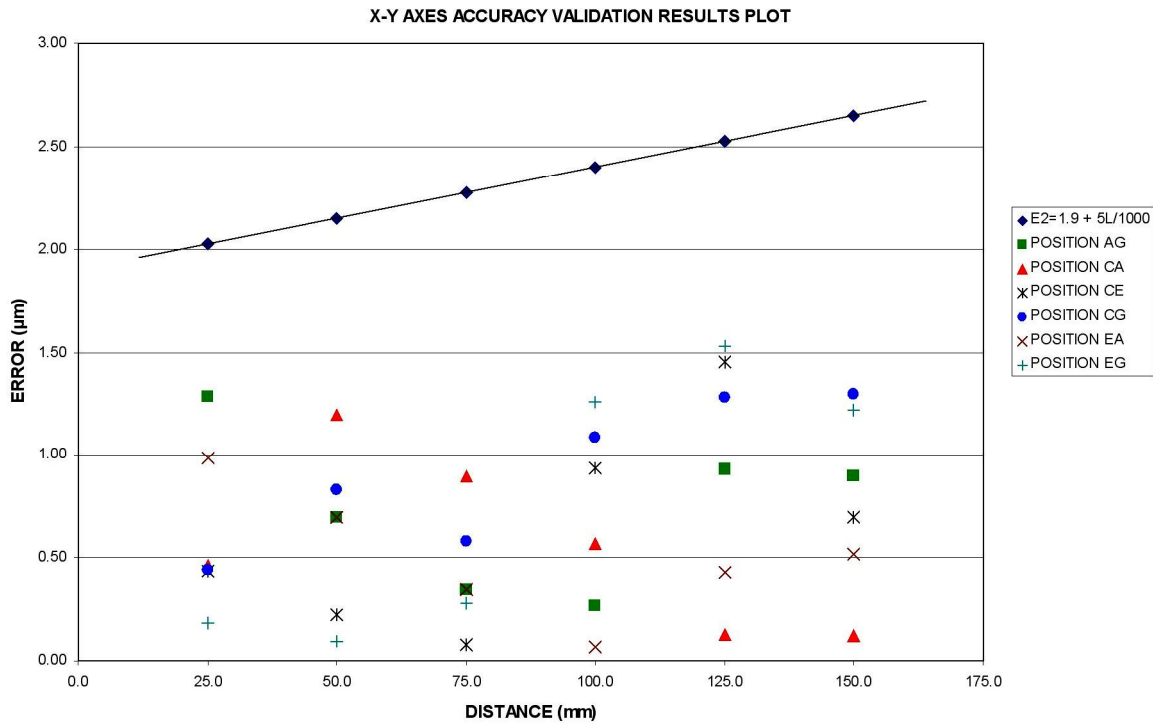



Figure 5 - 2: Calibration Error Chart Example

## 5.4 Cleaning

To the degree possible, the system should be kept in a clean environment, away from dirt, dust, oil and debris which could affect system performance or degrade the system’s mechanical and electronic parts. If a clean environment is not available, the machine should be kept as clean and protected as is possible. In harsh environments, preventive maintenance and factory service should be scheduled more frequently to keep the system in top working order.

	<p><b>WARNING:</b> Never pour fluid on the system when cleaning. Do not over-wet cleaning cloth. Excessive moisture can seep into mechanical or electrical parts, damage the equipment and possibly cause physical injury. As a precaution, unplug the system if needed before cleaning the system. Always unplug the system before using any flammable cleaning fluid.</p>
---	---

### 5.4.1 Cleaning External Surfaces

Wipe down with a clean, lint-free cloth moistened (not wet) with plain water or Simple Green®. Never wipe down with acetone or other harsh solvents, which may damage painted or plastic surfaces. Isopropyl alcohol may be used to clean surface contaminants where Simple Green proves ineffective.

### 5.4.2 Cleaning Optics

Avoid touching the exposed camera lens or Auxiliary Lens, since fingerprints will destroy optical coatings over time. Blow dust off of the lens gently using a can of compressed air, or use a lens brush to gently wipe off dust. Only touch lenses with proper cleaning equipment, and then only when necessary.

When the lens is soiled with grease, use reagent grade acetone to clean lens surfaces. Apply the acetone to a clean, dry cotton swab. Shake off excess to avoid over-wetting the lens. Gently wipe the lens surface while turning the swab to always present a clean surface to the lens. Wipe in a

circular manner moving from the center toward the outer edge of the lens. Try not to overlap cleaned areas. Do not reuse swab. Discard after one revolution, and repeat the procedure with a new swab. If reagent acetone is not available, use an alcohol-based lens cleaning fluid available from a camera supply or optometrist office. Lens-cleaning tissue may be used in place of swabs. Isopropyl alcohol evaporates too slowly to clean effectively.

### 5.4.3 Cleaning Mechanical Parts

To ensure a long, trouble-free service life, wipe down the system regularly to remove any dust or dirt from the system. Most critical components are covered and require no user service. Should the stage or column mechanics require service, please contact your Starrett representative.

## 5.5 Lubrication

Every 6 months, lead-screws may be lubricated with a small amount of Tri-Flow®. Apply to each screw and traverse the stage or column through the entire range of travel several times to distribute the lubricant. Use a clean soft cloth or paper towel to wipe up any excess.

	<p><b>NOTE:</b> Use only approved lubricants, as inappropriate lubricants can damage system components. Approved lubricants may be obtained by contacting Starrett or an authorized Starrett representative.</p>
---	--



## 5.6 Auxiliary Lens Replacement

Auxiliary (aux) lenses are available to alter the magnification range of the Manual / CNC optics. When changing the Auxiliary Lens, avoid touching any lens surfaces. No auxiliary lens is required for the standard 1X range of the system.

### Steps to change the lens:

1. Remove the ring light prior to changing the lens.
2. If an Auxiliary Lens is in place, unscrew the lens counterclockwise.
3. Verify the new lens and exposed lens of the primary optics assembly are clean and dust free.
4. Carefully screw in the aux lens clockwise, finger-tight only. Do not over-tighten the lens.
5. Update the lens setting in the QC5000 software. Refer to the QC5000 manual for details.

## 5.7 Bulb Replacement

	<p><b>NOTE:</b> The lights of the metrology system will generate heat. To preserve lamp life and reduce unnecessary heat buildup, turn the lights down whenever the system is not in use.</p>
	<p><b>WARNING:</b> Be sure to power the system down properly and unplug the unit from the power supply before opening the electronics enclosure.</p>
	<p><b>CAUTION:</b> The lamp bulbs are very hot and can cause burns if not allowed to cool properly.</p> <p>Do not touch any part of the new bulb when inserting. The inner reflective surface of the lens and the filament housing are particularly susceptible to damage. Oils from fingers and hands can contaminate the surface and shorten the bulb life. Use a clean cloth or tissue, or wear clean latex gloves to handle the new bulb.</p> <p>Take care not to get any part of the tissue or cloth caught in the bulb contacts to avoid a potential fire hazard.</p> <p>The bulb must be fully seated in the socket to prevent arcing and premature failure of the bulb and damage to the socket.</p>

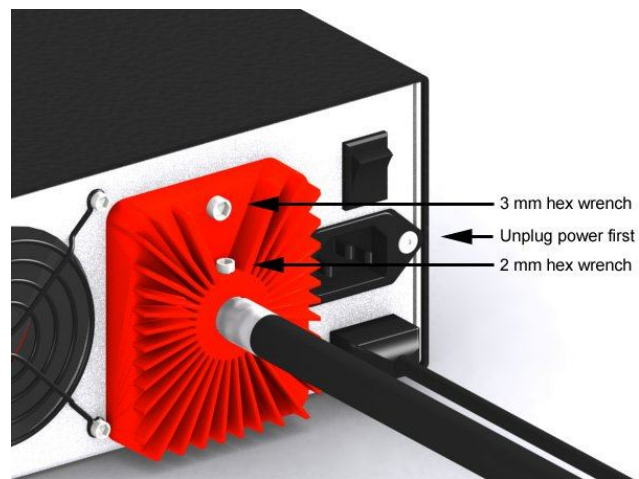

**Figure 5 - 3: Remove Bulb Housing**

**Steps to replace the bulbs:**

1. Verify which lamp needs to be replaced before powering the system down. The lamp sockets are labeled TOP, BOT and AUX corresponding to the three system lights.
2. Properly power the system down and unplug the unit from the power source.
3. Using a 2 mm hex wrench, loosen the light bundle retaining screw and remove the light bundle from the heat sink.
4. Using a 3 mm hex wrench, remove the heat sink / enclosure cover retaining screw.
5. Allow the bulbs to cool completely before removing the old bulb.
6. Using the ejector lever as shown, push the old bulb out of its socket.
7. Remove the old bulb by hand when the pins have cleared the socket.
8. Taking care not to touch the new bulb with bare hands, place the bulb in the socket.
9. Firmly push down as shown until the lamp pins are securely seated in the socket. The ejector lever will move back into the closed position when the bulb is fully seated.
10. Replace the cover and properly tighten the retaining screws.
11. Plug the unit in and power the system on to check proper bulb function.
12. If further assistance is required, please contact your Starrett dealer or the factory.

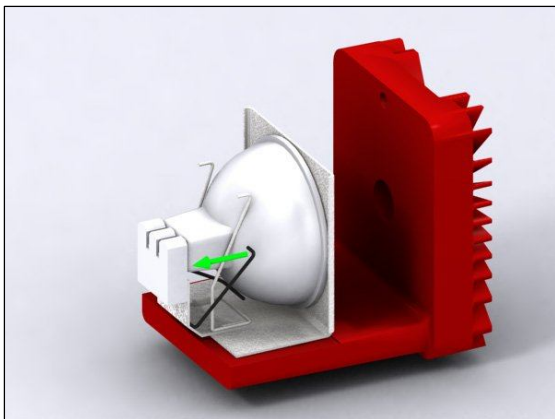

**Figure 5 - 4: Eject Bulb**

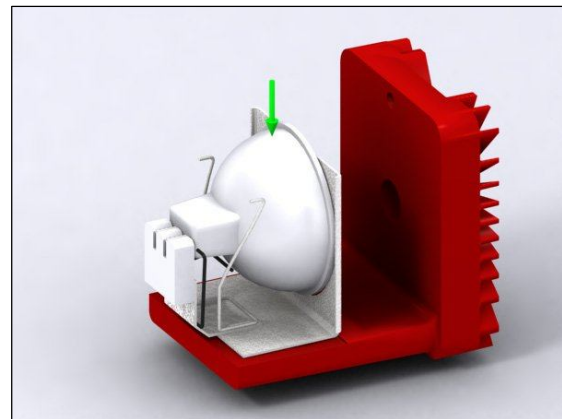

**Figure 5 - 5: Insert New Bulb**

## **5.8 Periodic Calibration and Maintenance Service**

It is recommended that a Galileo system be serviced and calibrated a minimum of every six (6) months to ensure proper function and accuracy. Under heavy usage conditions, it may be necessary to service the system more frequently. Please contact Starrett an authorized Starrett technician for this service.

## 6. GLOSSARY

The following terms may have additional meanings. The definitions that follow are in the context of the Galileo Video Metrology System.

<b>Accuracy</b>	The maximum error that the system will produce when measuring a calibrated standard.
<b>Auxiliary Lens</b>	An accessory lens that may be attached to the end of the optical subsystem to change the magnification range of Galileo metrology systems.
<b>Auxiliary Light</b>	An optional third light source for CNC series systems. The Aux light is a coaxial light, meaning that the light is along the same axis as the camera. Surfaces that face the camera are illuminated brightly, while surfaces angled away even slightly appear much darker. The result is a high-contrast lighting that can help sharpen edges for better detection by the Video Probe. By comparison, light that is not coaxial and shines from different directions (such as from the Ring Light) results in lower image contrast.
<b>Axis</b>	A direction which allows movement and along which dimensions can be measured. In Manual and CNC metrology systems, three mutually-perpendicular axes are X (left to right), Y (front to back), and Z (bottom to top). Measurement along the X and Y axes is accomplished by moving the metrology stage horizontally. Measurement along the Z axis is accomplished by moving the camera and optics vertically, rather than moving the metrology stage.
<b>AV</b>	Automated Video. "AV metrology system" is an alternative designation for "CNC metrology system."
<b>Blooming</b>	A condition caused by excessive light to the camera, where bright become over-saturated and appear larger than they really are. Avoided by decreasing illumination.
<b>CCD</b>	Charge Coupled Device. The solid-state image sensing element of a video camera.
<b>CNC</b>	Computer Numerical Control. In CNC metrology systems, motion of the stage and optics is both motorized and computer controlled, making these system ideal for repetitive measurements in a production environment. Non-CNC system may also be motorized, control will be manual by an operator.
<b>DRO</b>	Digital Readout. Term used to describe the Quadra-Chek <sup>®</sup> QC300 operator interface unit of Manual Galileo systems.
<b>FOV</b>	Field of View. The region of the metrology stage that the camera sees and displays in the video image. "FOV measurement" refers to a measurement that can be done in a single field of view without moving the stage or camera.
<b>MAG</b>	Shorthand for magnification.
<b>Pixel</b>	A picture element. Term used to describe the individual light detectors of a CCD sensor and the individual light emitters of a video monitor. The spacing and number of pixels determines the resolution of a video metrology system.